

GENERATOR BACKUP Web Server

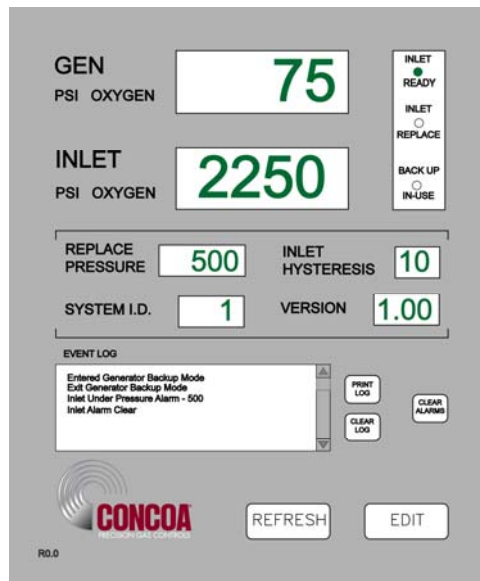

INSTALLATION AND USER'S GUIDE

Carefully Read These Instructions Before Operating

Controls Corporation of America
1501 Harpers Road • Virginia Beach, VA 23454
Telephone 1-800-225-0473 or 757-422-8330 • Fax 757-422-3125
www.concoa.com

August 2011
Revision A

Index

What You Need.....	1
Connecting the Web Server	1
Gaining Access to the Web Server	8
Using the Web Server	8
Features	8
STATUS Screen.....	9
EVENT LOG	11
EDIT SCREEN	12
Password	12
Modifying a Parameter	15
EMAILING.....	18
EMAIL CONFIGURATION	20
Troubleshooting	22
Configuration Data.....	23
Warranty Information	24

Tables

Table 1 STATUS screen functional descriptions.....	9
Table 2 EDIT screen functional descriptions.....	13
Table 3 EMAIL screen functional description.....	19
Table 4 EMAIL CONFIGURATION	20
Table 5 TROUBLE SHOOTING GUIDE	22

WHAT YOU NEED

Computer: Pentium 4 or better
Monitor: Capable of MINIMUM display resolution 1024 x 768
Operating System: Microsoft Windows XP, XP Professional, Vista
Local Area Network Connection
Internet Browser: Internet Explorer, Mozilla FireFox

It is highly recommended that the installation and setup for the Generator Backup System Web Server (IWS) be performed by a person with a working knowledge of the internet, local area networks and computers, such as a LAN Administrator.

CONNECTING WEB SERVER

The IWS is designed to communicate via a local area network connection. Power to the Generator Backup System should be OFF. Connect the IWS to the network via an RJ-45 network cable. The RJ-45 connection on the Generator Backup System is located on the bottom of the Generator Backup System. It may be necessary to remove the protective cover to access the RJ-45 connection on the Generator Backup System. Apply power to the Generator Backup System and allow a minimum of 30 seconds for the IWS to find the network.

When the IWS is first initialized it will try to acquire an IP address from the DHCP server on your network. For the device to work properly it will be necessary to assign the device a permanent IP address. Ask the systems LAN Administrator to identify and record an IP address that will not be used for any other device. It may be necessary to “reserve” this IP address on your company’s DHCP server.

Identify a PC on the internal company network that you wish to use to configure the IWS. A CD containing software to assign a permanent IP address is included with the documentation. This only needs to be done one time on one PC. Once configured, any other PC on the network may view the IWS. Install the CD provided into the CD drive on this computer. View the contents of the CD and double click on the file named “Device Installer. This will load the Device Installer Application. Once the software is installed it will show up in the Programs list on your computer. It is listed under Programs/Lantronix/DeviceInstaller 4.2/DeviceInstaller. Start the Device Installer software.

When the Device Installer program starts, it will search for any IWS devices that are connected to the network. It should find the IWS that has just been installed.

The first screen you will see is shown in Figure 1.

Figure 1

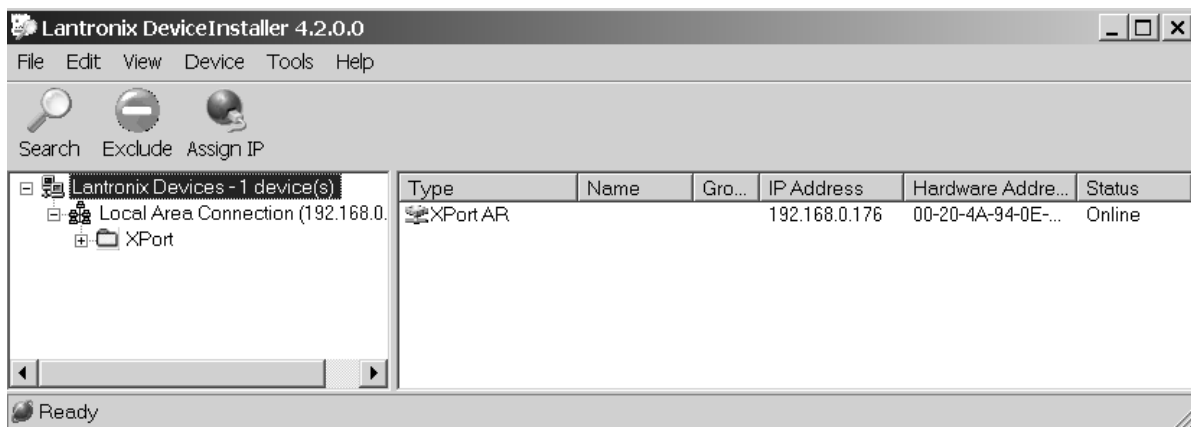

Using the Mouse, click on the “+” box next to the word Xport to expand the information (Figure 2).

Figure 2

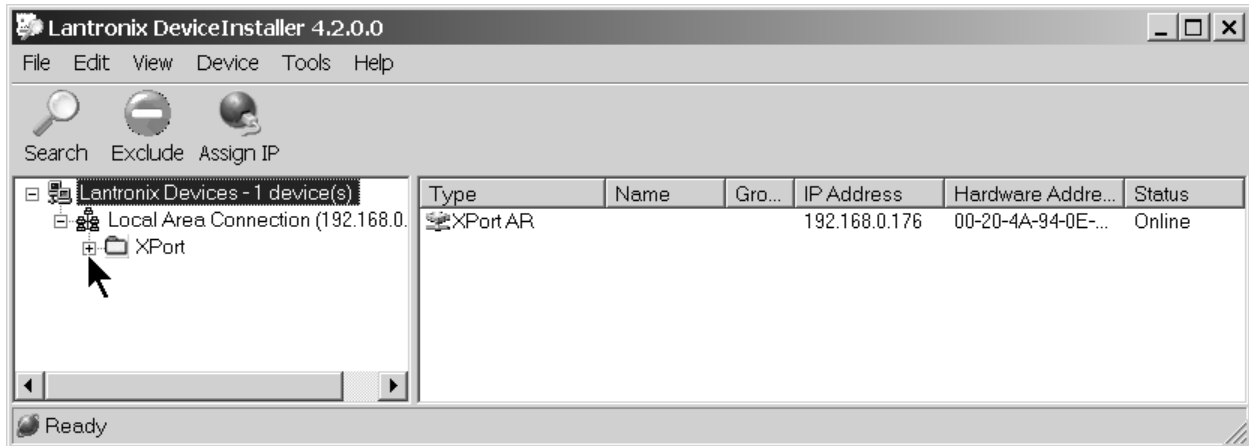

Next, use the Mouse to click on the “+” box next to the words “Xport AR – firmware....” to expand the tree to see the IP address of the IWS (Figure 3).

Figure 3

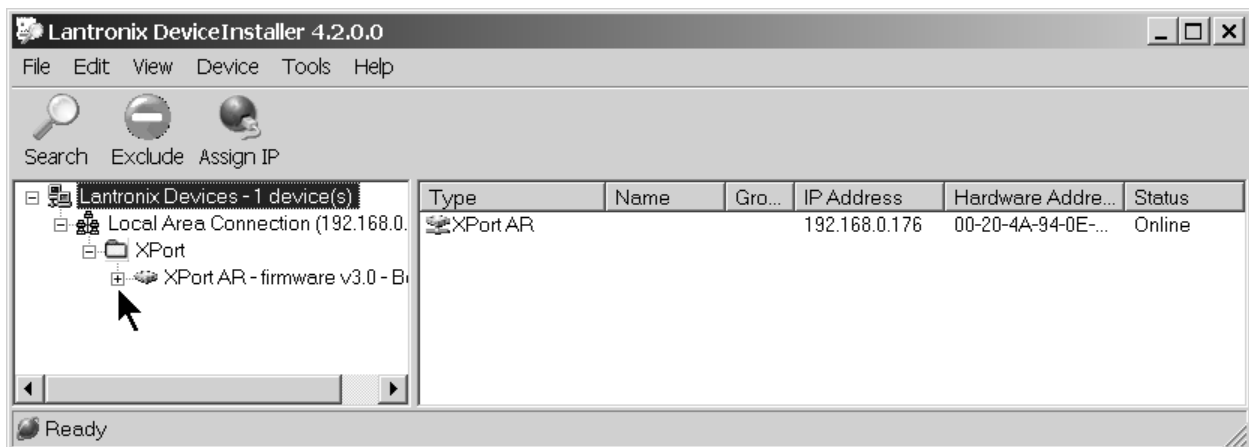

Use the mouse again and double click on the IP address shown in the tree (Figure 4). Wait until you see the screen in Figure 5.

Figure 4

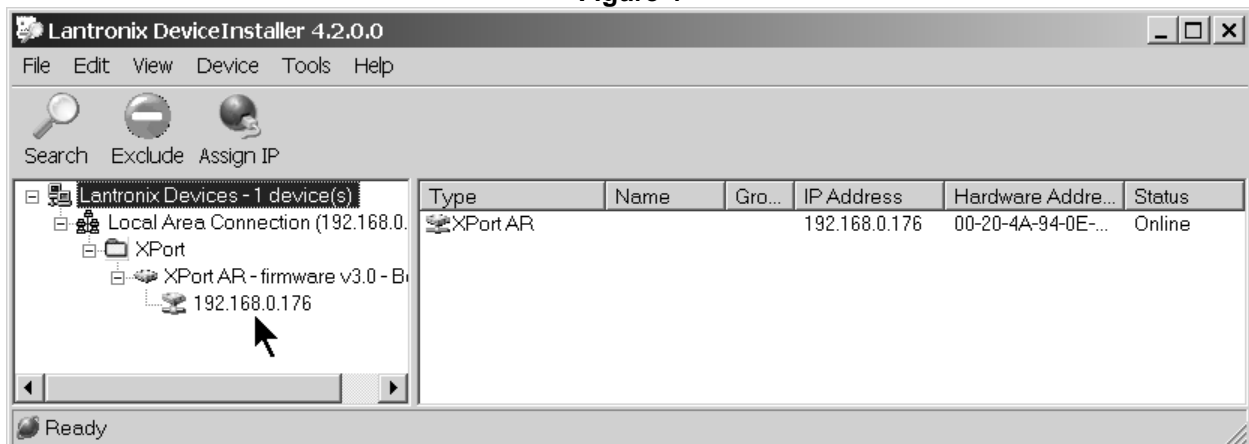
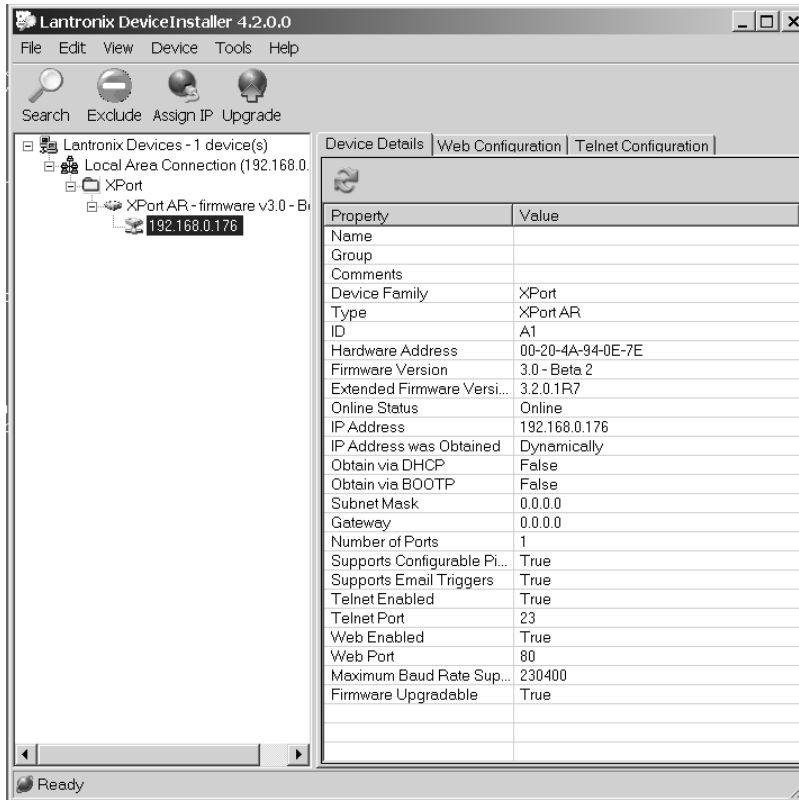

Figure 5



Using the Mouse select the “Assign IP Address” icon at the top of the screen (Figure 6). Figure 7 should appear.

Figure 6

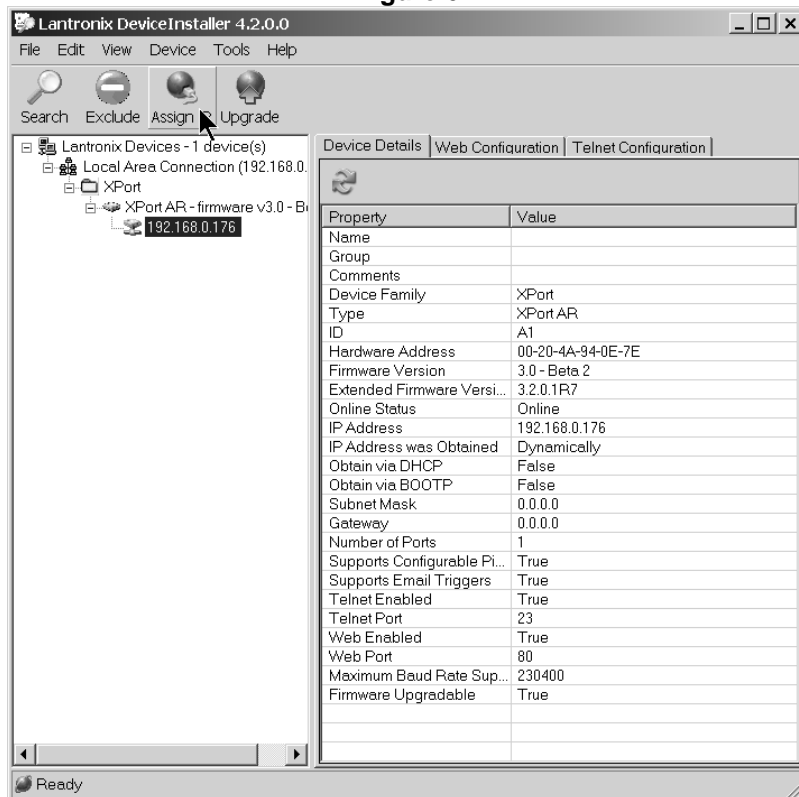
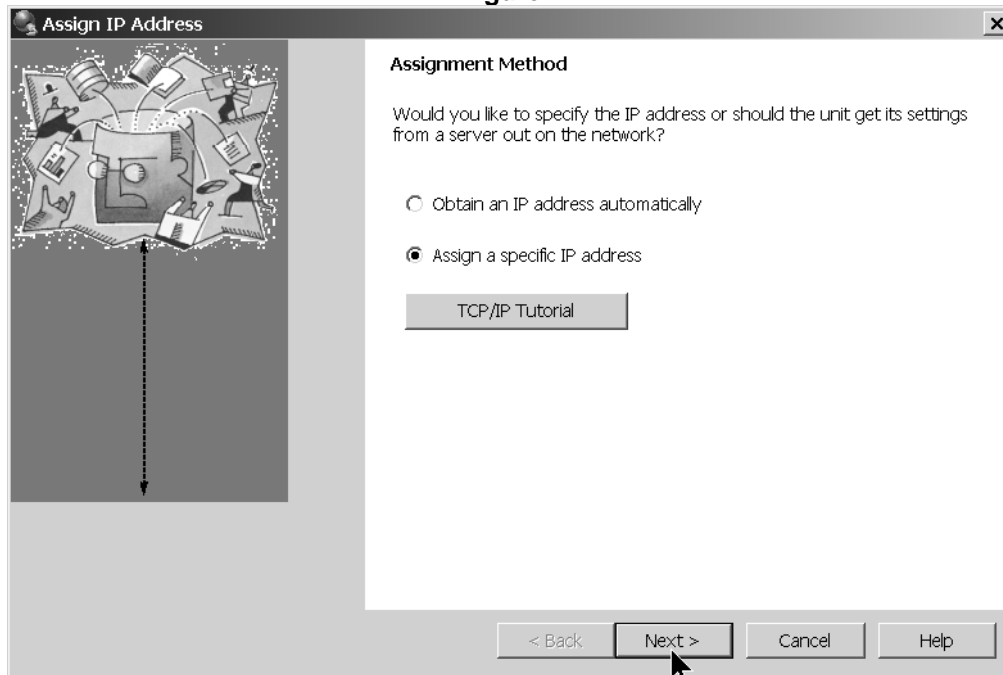
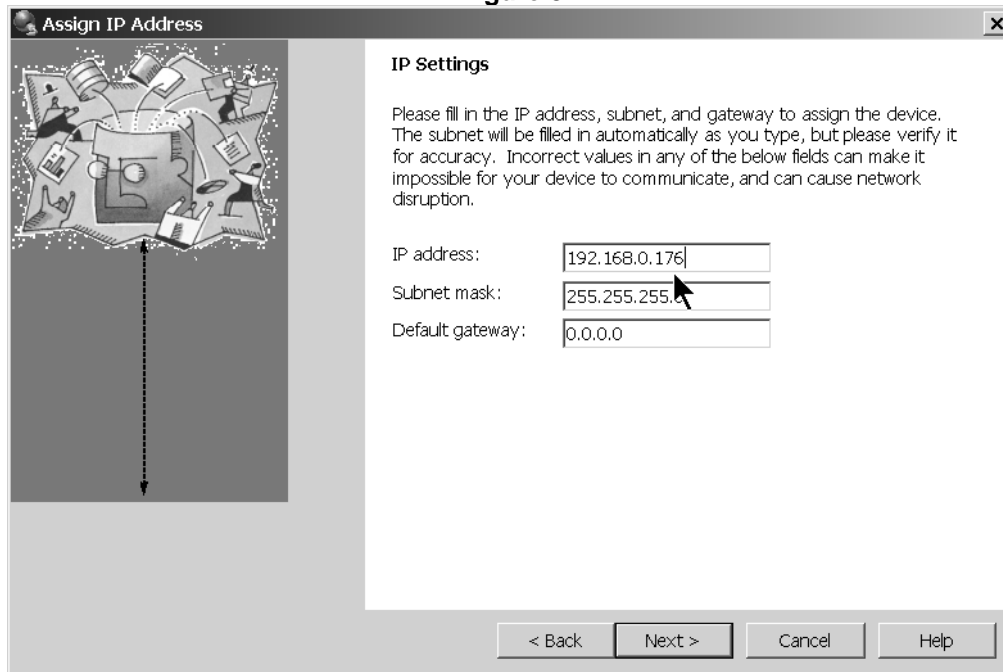

Figure 7



Click on the “Next” box. Figure 8 should appear. Notice that an IP address appears in the IP address window. This is the IP address that the IWS has assigned itself.

Figure 8



Replace the IP address in the IP Address window with the IP address that the LAN Administrator has reserved for the device. Example shown in Figure 9. **MAKE SURE THAT YOU ENTER A VALID IP ADDRESS FROM YOUR LAN. IF THIS IP ADDRESS IS ENTERED INCORRECTLY THE IWS CAN BE CONFIGURED INCORRECTLY AND MAY BECOME INOPERABLE.**

Figure 9

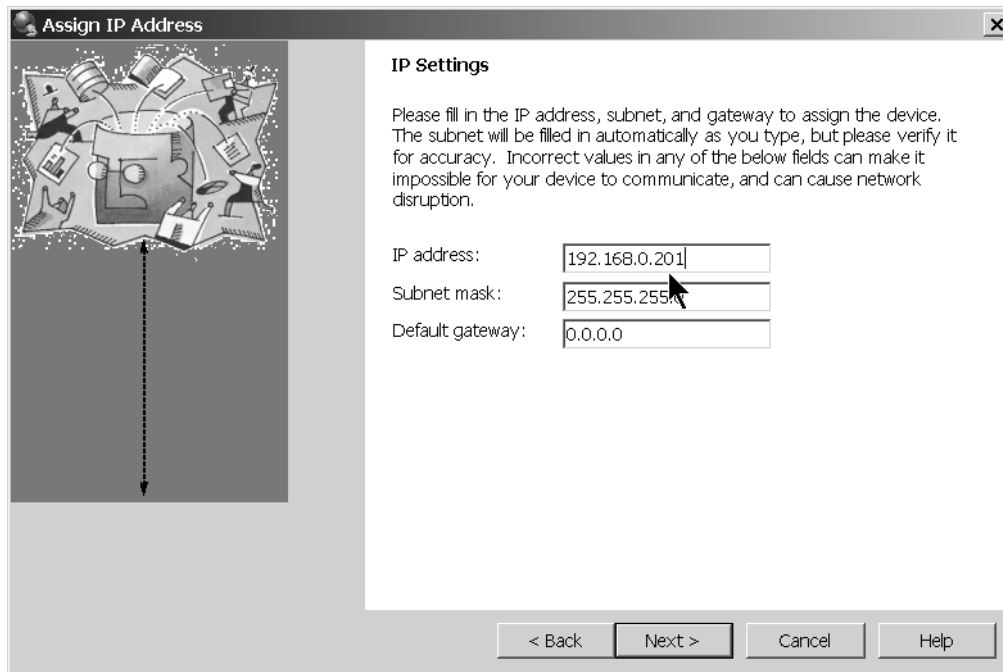

Click "Next" (Figure 10). Figure 11 screen should appear.

Figure 10

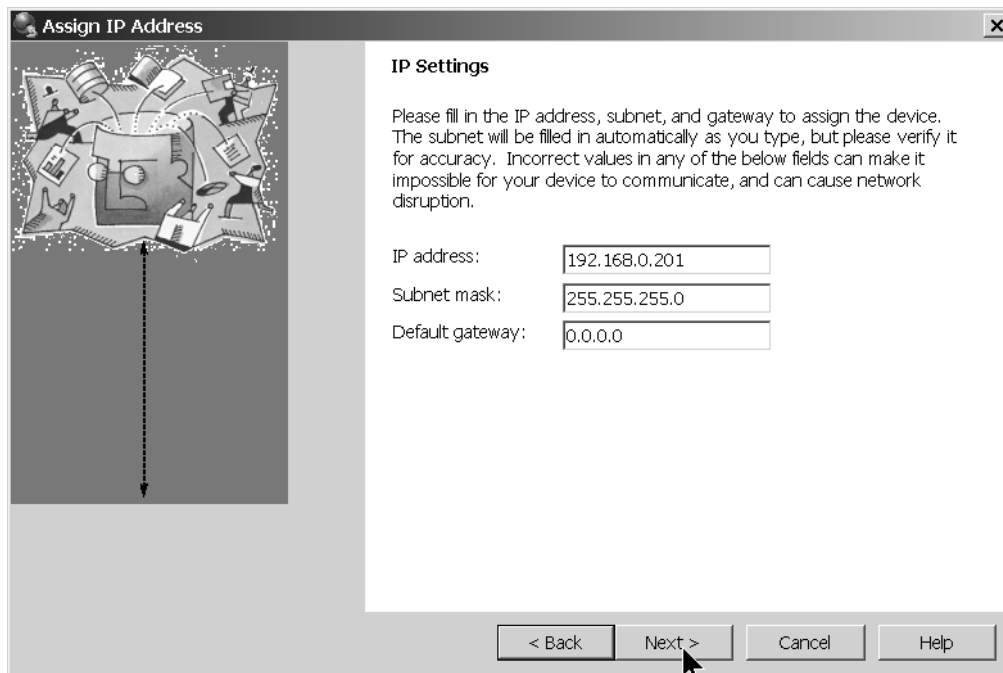

Click “Assign” on the screen. (Figure 11). Watch the progress bar (figure 12) until the message “completed successfully” appears below it. Click “Finish”. The screen in Figure 13 should appear and the new IP address will be shown (see arrow in figure).

Figure 11

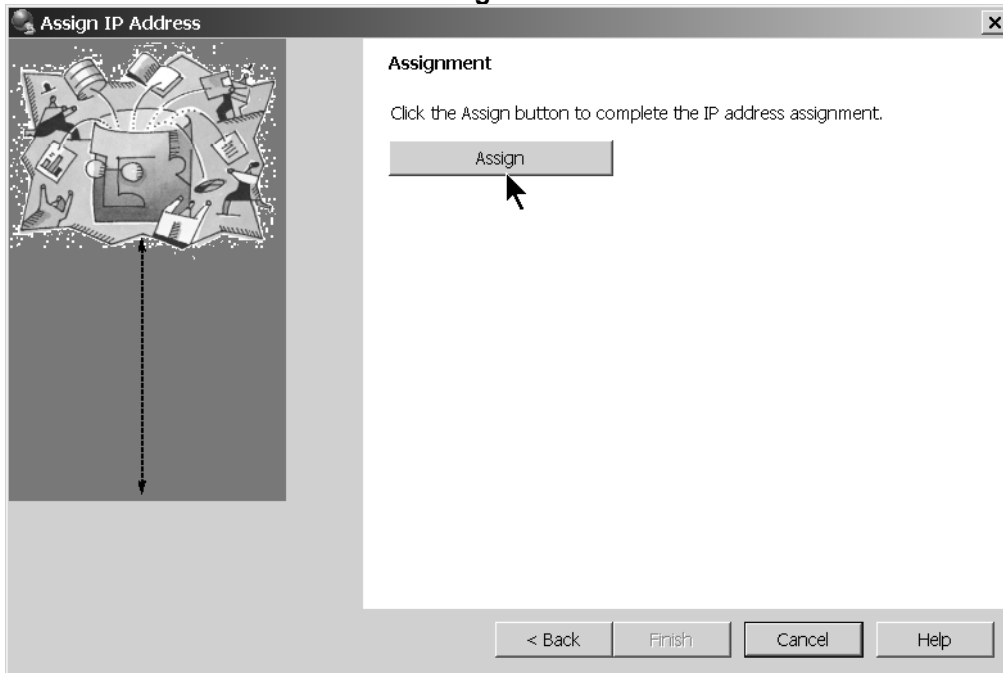

Figure 12

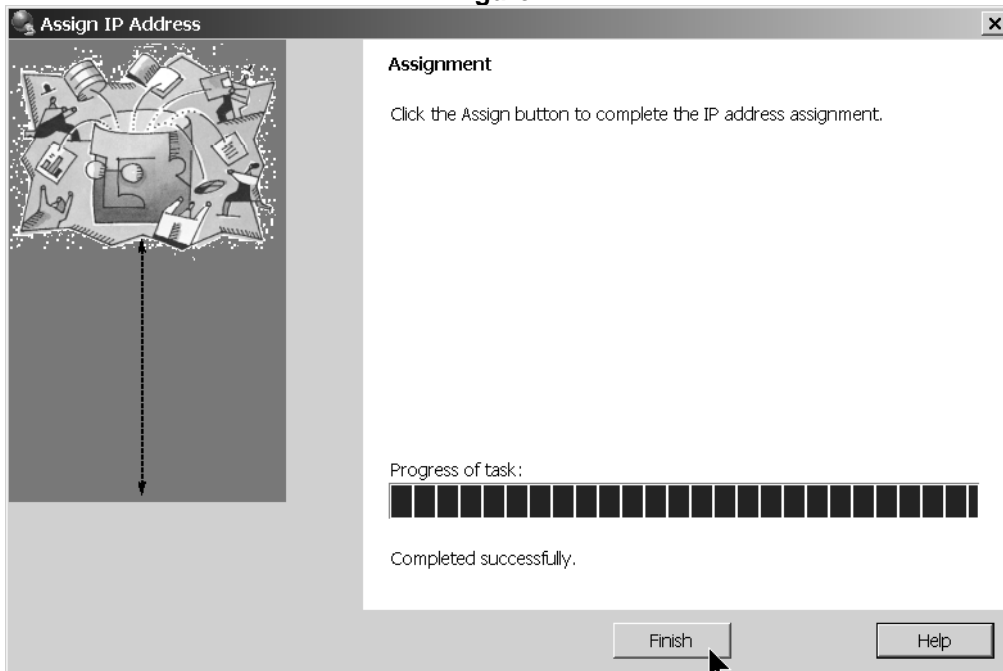
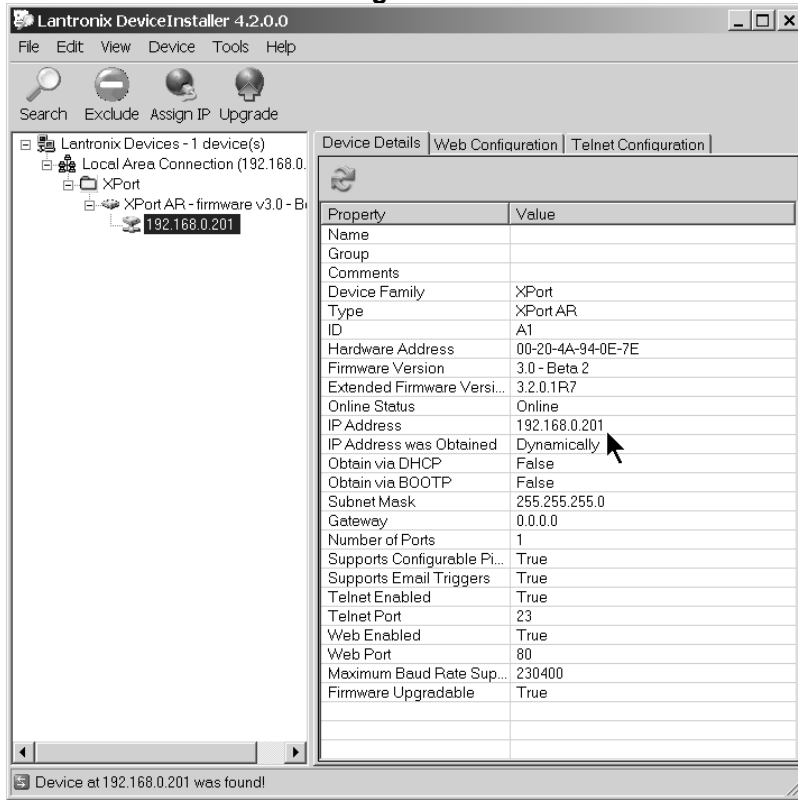
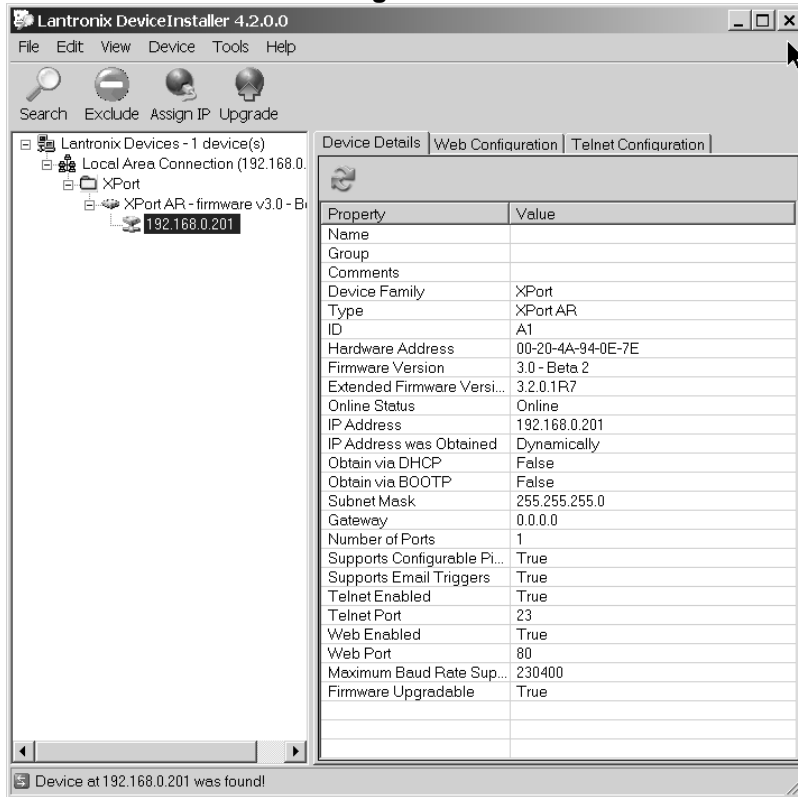

Figure 13



Close the program by clicking on the in the upper right corner (Figure 14) or by clicking “File/Exit” from the pull down menu. The IWS is now ready for use

Figure 14



GAINING ACCESS TO THE WEB SERVER

Using either Internet Explorer or Firefox and the newly assigned IP address (xxx.xxx.x.xxx), enter the following in the address box at the top of the screen:

<http://xxx.xxx.x.xxx/gassource/status.html>

If connected properly, an image similar to the one in Figure 15 below should appear on your screen.

ADDING IWS TO DESKTOP

For convenience the IWS should be added to your favorites and/or your desk top. To do this, reduce the IWS image using the “Restore Down” icon in the upper right corner of the screen so that it only occupies a portion of your desktop. Next, open up favorites and find your new entry for the IWS and drag it over to the desk top. You may wish to rename the icon so that it has a name that is easily recognized for the device being used. The IWS is now ready to use. Refer to the section “USING THE WEB SERVER” to learn what functions it has and how to use it.

Figure 15

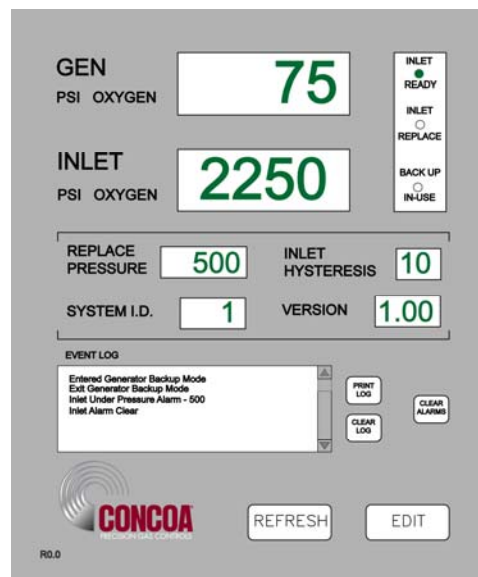

USING THE WEB SERVER

FEATURES:

The IWS has a number of useful features. The STATUS screen is what appears when the IWS is first accessed. This screen provides the ability to monitor a number of parameters as well as providing an “event log” that allows viewing of Generator Backup activity. Clicking on the EDIT button will bring the user to the EDIT screen. Here it is possible to change various parameters within the Generator Backup System. Also on the EDIT screen is a button marked EMAIL. Clicking on this button will bring the user to the EMAIL setup screen. The IWS has the capability of emailing any activity that may occur while the Generator Backup System is in use. Each screen and its function will be explained in subsequent pages of the manual.

STATUS SCREEN

Figure 16

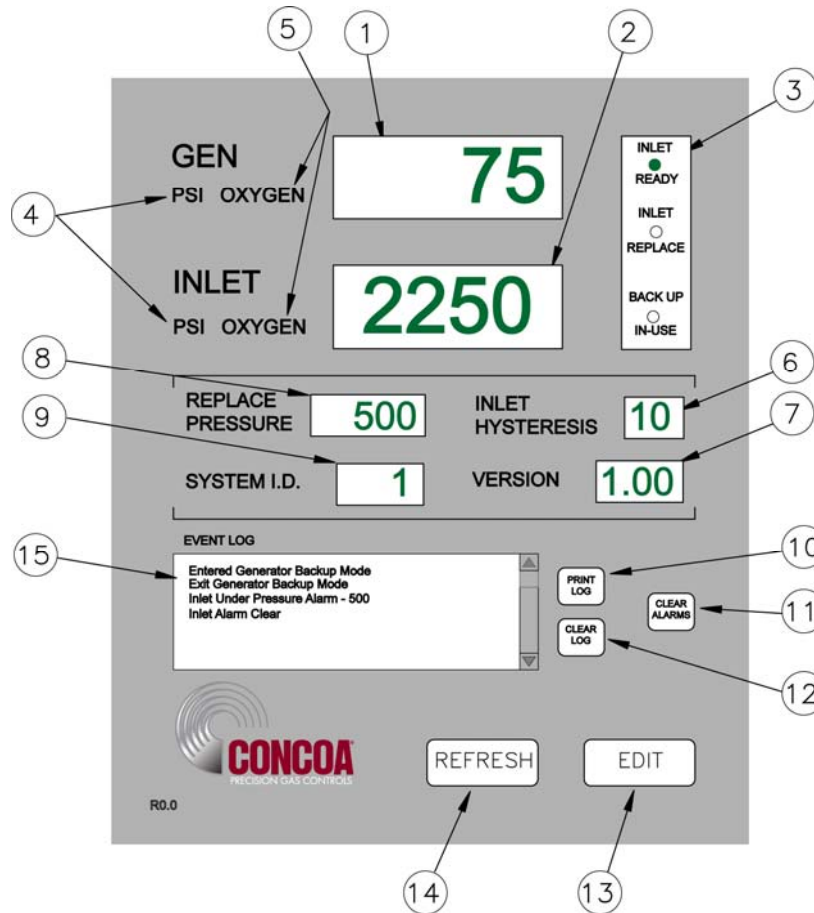

Table 1 that follows provides a description of each of the parameters on the screen (Figure 16)

Table 1

Bullet	Item	Description
1	Generator Pressure Display	Displays the Generator Pressure
2	Inlet Pressure	Displays the Inlet Pressure
3	System Status	Radio buttons display the current status of the inlet gas supply. <ul style="list-style-type: none"> • INLET READY - Green Ready indicates that there is enough gas on the inlet so it can be used. • INLET REPLACE - Red Inlet Replace indicates that the inlet pressure supply needs to be replaced. • BACKUP IN-USE – Green indicates the generator backup system is in use.
4	Units of Measure	Text describes the units of measure the pressures are being displayed in.
5	Gas Type	Text describes what gas is being supplied
6	Inlet Hysteresis	This is a preset pressure value that is used to prevent the Generator Backup System from “dithering” at the alarm point.
7	Software Version	This is the revision level of the firmware in the device

Table 1 (cont.)

Bullet	Item	Description
8	Replace Pressure	This is the pressure setting that the inlet pressure will alarm at.
9	System ID	This is a number that can be assigned by the user to identify the Generator Backup System.
10	PRINT LOG button	This button allows the printing of the contents of the event log to a users printer.
11	ALARM CLEAR button	Normally alarms that occur when using cryogenic cylinders must be manually reset by pressing the "RESET" button on the front panel of the system. Clicking this button allows the reset to be performed remotely.
12	CLEAR LOG button	This button clears the contents of the event log
13	EDIT button	Clicking this button will bring the user to the EDIT screen where changes to parameters can be made. The EDIT screen is password protected
14	REFRESH button	Clicking on this button will force an immediate display update. Normally the IWS updates the display approximately every 4-5 minutes unless an "event" occurs. An "event" is defined as an alarm or any activity such as pressing a button that causes switching or a change in cylinder selection
15	EVENT LOG	This is a location used to list any events that may occur

EVENT LOG

The Event Log provides a record of any events that may occur while the Generator Backup is running. This can be an alarm condition or a key press. Essentially, any “event” that may occur either as a result of a response to a change in conditions or operator intervention. A list of “events” that could be displayed in the event log is shown below.

- Entered Gen Backup Mode
- Exit Gen Backup Mode
- Inlet Under Pressure Alarm – “value”
- Inlet Alarm Clear

The word “value” is replaced by a pressure in psi.

The Event Log can store up to 50 events. Once the quantity of events reaches 50 it will continue to list the events but push events off the list starting with the first one. The list will be maintained until it is cleared. To clear the Event Log, click on the “CLEAR” button.

The Event Log can also be printed if a permanent record is needed. The PRINT function can use whatever printer the user’s computer is connected to. To print the event log, click on the PRINT button. A normal windows print screen will appear.

ALARM CLEAR

Alarms that occur when using cryogenic cylinders must be manually reset. This is usually done from the front panel of the Generator Backup System when empty cylinders are replaced. If the reset button is not pressed the Generator Backup System will not switch to the side with fresh cylinders because it still thinks it is in alarm. If for any reason this Reset button on the front panel is not pressed when cylinders are replaced it is possible to reset the alarm remotely using this feature. Clicking this button will cause the pop-up screen shown in Figure 17 to be displayed. Click on “Yes” to reset or “No” to cancel the operation.

Figure 17

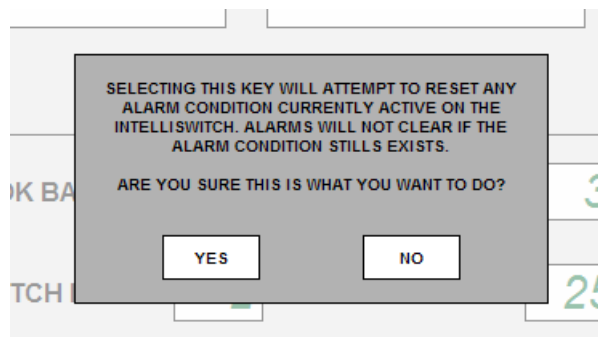

EDIT SCREEN

The EDIT screen allows the user access to the Generator Backup System operating parameters as well as EMAIL options. This screen is password protected. The password is fixed and cannot be changed. To enter the EDIT screen, click on the EDIT button at the bottom of the STATUS screen. The Password pop-up, Figure 18, will appear. Click in the blank text box and type: **19490321**. Now either click on “OK” or press ENTER on the keyboard. The EDIT screen will appear (Figure 19).

Figure 18

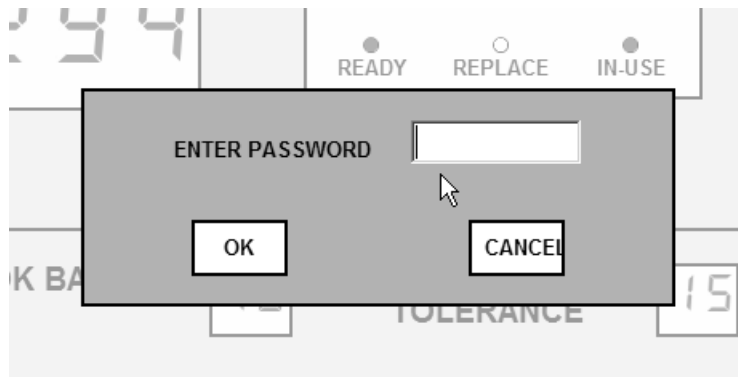
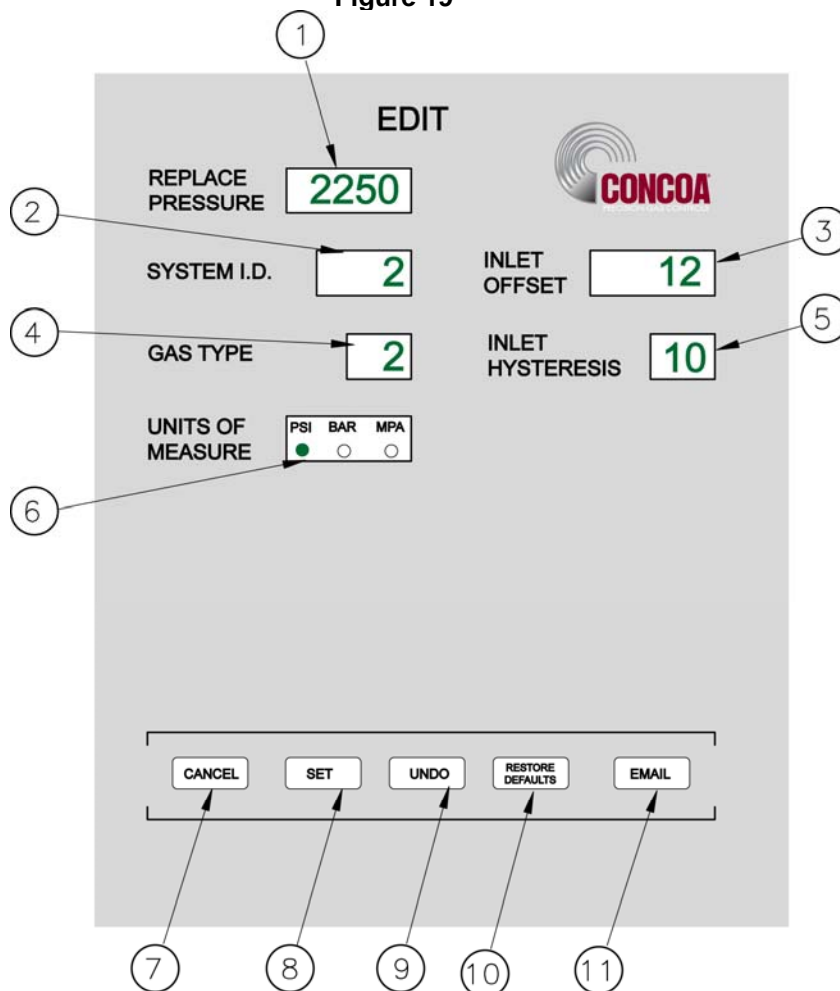

Figure 19



The EDIT screen displays the parameters that can be modified individually and directly. The lower portion of the screen contains various buttons that invoke various functions. The SET button (Item 8) is used to transfer the parameters on the EDIT screen to the Generator Backup System. This gives the user an opportunity to review and/or modify any value before the parameters are permanently changed. The other buttons will be explained further along in this manual.

Pop-up messages are used throughout this screen to aid in setting parameters. All items and button “RESTORE DEFAULTS” have associated pop-up messages that will appear when the mouse pointer is over them. The “SET” button and “UNDO” buttons will show pop-up messages after they have been selected. Use these messages as guides to correctly set values on this screen.

Figure 19 and Table 2 describe the various parameters on the screen.

Table 2

Bullet	Item	Description
1	Replace Pressure	This is a preset pressure in the Generator Backup System used to determine when an inlet can no longer provide enough gas pressure to the outlet regulator. Data range: 50-500psi
2	System I.D.	This is a number that can be assigned by the user to identify the Generator Backup System. Data range: 1-254.
3	Inlet Offset	This is a value that can be used to adjust the pressure transducer reading for the inlet. This value should only be changed if it is necessary to recalibrate the transducer. Changing this value will change the inlet pressure reading. A (+) or (-) value may be entered here. Refer to “Calibrating Transducers” section of the Generator Backup System user’s manual. Data range: +/- 200 psi.
4	Gas Type	Displays the gas type the Generator Backup System is controlling. The pop-up message will show the choices. The choices for gas type are numbered. Enter the number next to the gas type in the text box. The name of the gas will appear on the status screen next to units of measure Data range:1-99 (refer to pop-up message for details)
5	Inlet Hysteresis	This is a preset pressure value that is used to prevent the Generator Backup System from “dithering” at the inlet alarm point. Data range: 10-50 psi.
6	Units of Measure	Choices are PSI, BAR and MPA. Pressures will be displayed on the STATUS screen in the units selected.
7	CANCEL Button	This button is used to cancel any operation while in the EDIT screen. If any parameters in the EDIT screen have been modified and the “SET” button has not been selected “CANCEL” will abort any modifications before bringing the user back to the STATUS screen. Clicking on this button after using “SET” will bring the user back to the STATUS screen with the changes made.
8	SET button	This button is used to send the changed parameters to the Generator Backup System. A pop-up message will appear when this button is selected asking the user to verify their intention to change the parameters.

Table 2 (cont.)

Bullet	Item	Description
9	UNDO button	This button will appear after a parameter on the screen has been changed. Clicking this button will restore <u>all</u> changed parameters to their original values. It will not work once the SET button has been used.
10	RESTORE DEFAULTS button	The setup parameters that are set at the factory for the Generator Backup System can be restored using this button. This is useful in cases where a user is unsure that the Generator Backup System parameters are correct or have been modified in the field using the EDIT screen.
11	EMAIL button	Clicking this button will bring the user to the setup screen for EMAIL. EMAIL is used to email in the case of an alarm condition. Refer to the section for EMAILING in this manual for more information.

MODIFYING A PARAMETER

A. EDIT SCREEN NUMERIC VALUES (Items 1-5 Figure 19)

Position the mouse pointer over the parameter to be changed. In the example below, it is positioned over the REPLACE PRESSURE. Notice that the pop-up message for this parameter is displayed (Figure 20). Next, click the mouse while over the text box. Notice that the outline that was around the text box has changed (Figure 21). This is an indication that this text box has been selected to accept data. Enter the new value for the REPLACE PRESSURE. When the first number is entered, the data currently in the text box will be cleared (Figure 22). Complete the value (Figure 23).

The <Backspace> key may be used to correct a bad entry. This key will step back through the number entered one digit at a time. The <ESC> key can be used to cancel the entry. Either of these keys may be used for the current entry until the user clicks the mouse on another parameter or in the open space on the screen.

The method for changing all text boxes is the same. Use the pop-up message as a guide to entering the correct range of values.

Click on the “SET” button to transfer the new parameters to the Generator Backup System. In doing so the pop-up message in Figure 24 will be displayed. Confirm changing the parameters by clicking on the “YES” box. If it is necessary to abort the changes click on the “NO” box and the IWS will return to the normal EDIT screen. All the changes that were made will still be on the screen. More modifications can be made or all the changes can be voided and the original values restored to the screen by clicking on the “UNDO” button.

Clicking the “CANCEL” button before setting the new parameters will void any changes made and return the user to the STATUS screen. Clicking the “CANCEL” button after setting the new parameters will return the user to the STATUS screen with the new parameters set in the Generator Backup System.

Figure 20

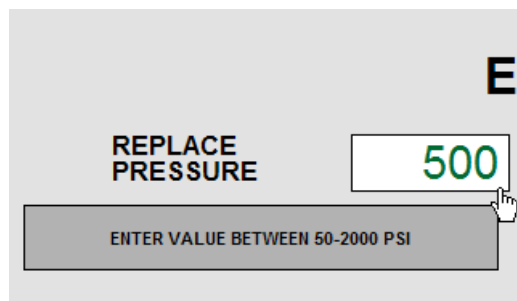

Figure 21



Figure 22



Figure 23

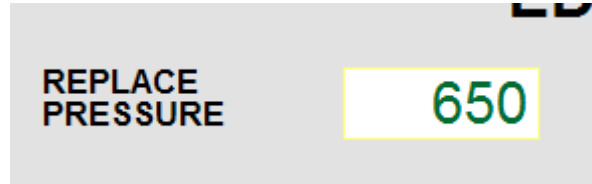
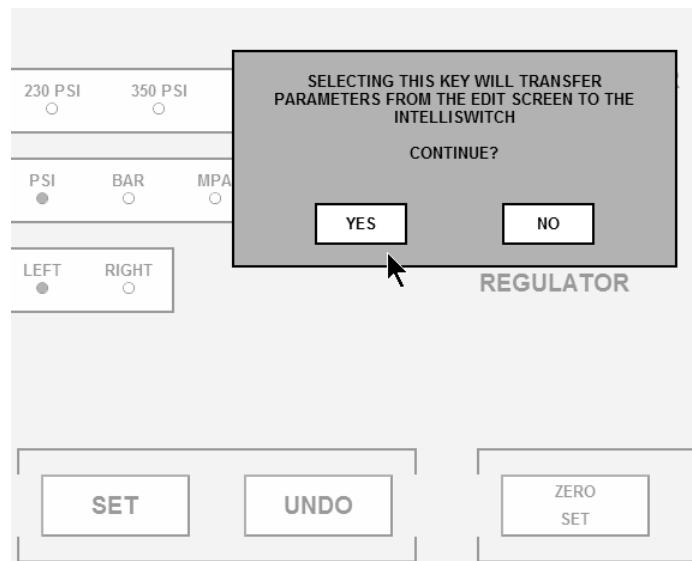

Figure 24



B. EDIT SCREEN RADIO BUTTONS(Item 6 Figure 19)

The example that follows uses the Units of Measure selection. For this example, it is initially set to “PSI” (Figure 25). Using the Mouse, click on the radio button that represents the selection to be made such as “BAR”. The radio button representing “PSI” will change from green to clear and the one selected (BAR) will change from clear to green (Figure 26).

Click on the “SET” button to transfer the new parameters to the Generator Backup System. In doing so the pop-up message in Figure 27 will be displayed. Confirm changing the parameters by clicking on the “YES” box. If it is necessary to abort the changes click on the “NO” box and the IWS will return to the normal EDIT screen. All the changes that were made will still be on the screen but will not have been transferred to the Generator Backup System. More modifications can be made or all the changes can be voided and the original values restored to the screen by clicking on the “UNDO” button or clicking on the “CANCEL” button to return to the STATUS screen.

Clicking the “CANCEL” button before setting the new parameters will void any changes made and return the user to the STATUS screen. Clicking the “CANCEL” button after setting the new parameters will return the user to the STATUS screen with the new parameters set in the Generator Backup System.

Figure 25

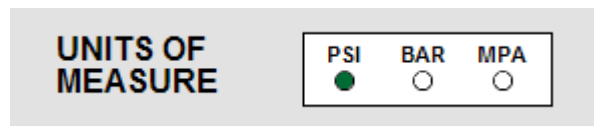

Figure 26

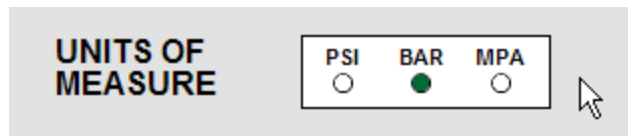
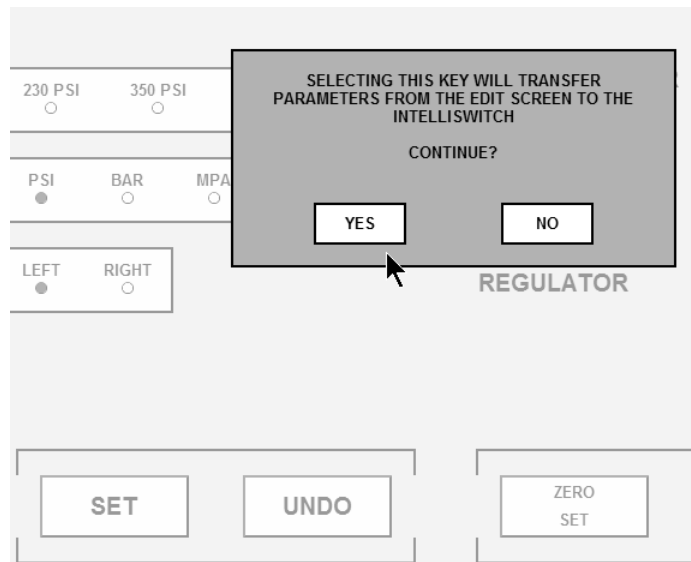

Figure 27



EMAILING

The IWS has an advanced feature that allows emailing in the event of an alarm or an event. The IWS is only capable of sending email. It cannot receive email. PROPER SETUP OF THE EMAIL FUNCTION FOR THE IWS REQUIRES A KNOWLEDGEABLE LAN ADMINISTRATOR.

EMAIL

EMAIL is used to report “alarm” conditions only. Reported alarm conditions are:

- Entered Gen Backup Mode
- Exit Gen Backup Mode
- Inlet Under Pressure Alarm – “value”
- Inlet Alarm Clear

The word “value” is replaced by a pressure in psi.

To access the EMAIL screen, mouse click on the “EMAIL” button on the EDIT screen. An image similar to Figure 28 should appear on your screen.

Table 3 provides an explanation of the contents of the EMAIL screen

Figure 28

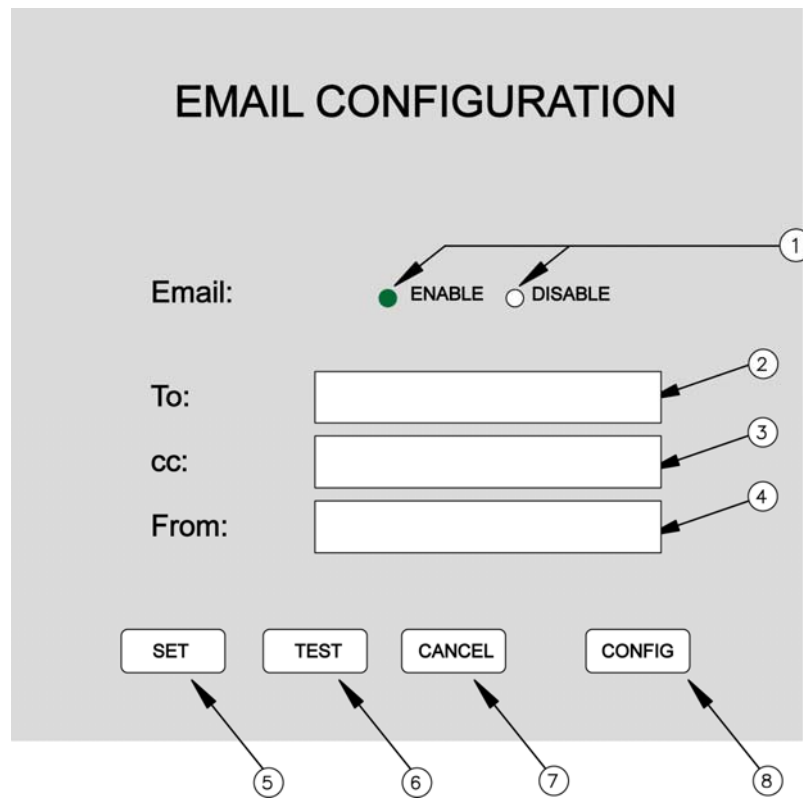

Table 3

Bullet	Item	Description
1	Email Enable	The radio buttons are use to enable or disable the EMAIL function. Clicking on the radio button works the same as in other radio buttons in the EDIT screen
2	To:	This is the location to enter the email address of any recipients the user wishes to receive notification of an "alarm". If the user wishes to send to more than one recipient separate the email addresses by a semicolon.
3	CC:	This location holds the email address for anyone the user wishes to copy in the case of an "alarm". If the user wishes to send to more than one recipient separate the email addresses by a semicolon.
4	From:	This location holds the email address of the person or system* sending the email.
5	SET button	Clicking this button will save the parameters that have been entered.
6	TEST button	This button allows the user to test the email function. Clicking this button should send out an email message to the name(s) entered in the "To:" and "cc:" boxes
7	CANCEL button	Clicking this button will return the IWS to the EDIT screen. If there is information entered that has been saved by clicking the "SET" button those values will show in the boxes the next time the EMAIL screen is opened. If the "CANCEL" key is used before the "SET" button is used, nothing will be saved.
8	CONFIG button	This button brings the user to the system configuration screen. The system configuration screen is used to configure the Generator Backup System so that it can operate its email function.

* - The LAN Administrator may choose to create an email address for the Generator Backup System so that the recipient of an email will know which Generator Backup System is reporting. Example:
laser_room@company.com.

In order to properly operate the IWS email, the Primary and Secondary DNS Servers, Default Gateway, Overriding Domain, and Server Port must be identified and entered. These values are set in the System Configuration screen which is accessed by clicking on the "CONFIG" button. This information should be identified by the user's **LAN Administrator**.

EMAIL CONFIGURATION

In order for the web server to properly communicate with email servers there are certain parameters that need to be identified and configured. A “System Configuration” screen is available to enter these parameters. The “System Configuration” screen is accessed through either the EMAIL screen by clicking on the “CONFIG” button.

It is important that a knowledgeable LAN administrator identify and enter these parameters. Entering incorrect values can cause the web server to stop functioning.

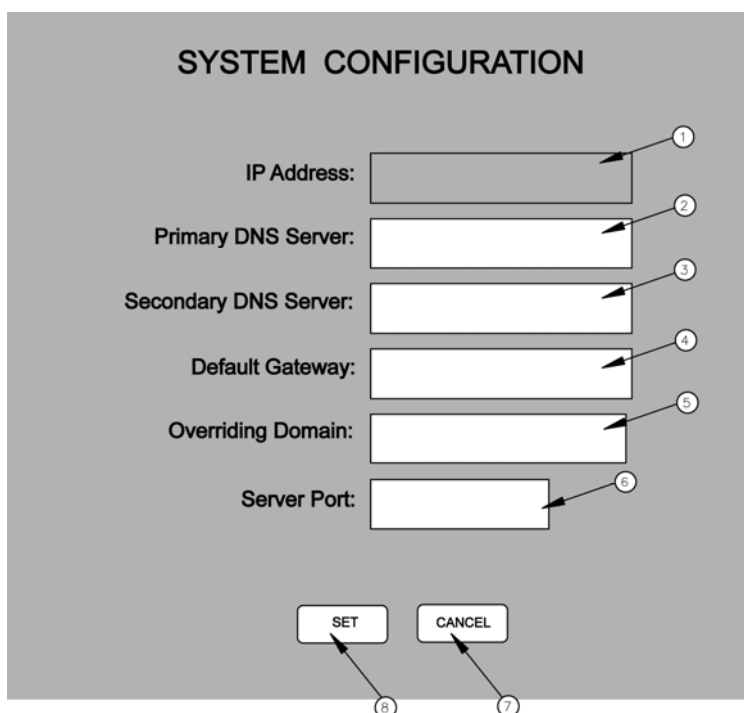

Table 4

Bullet	Item	Description
1	IP Address	This identifies the IP Address at which the Web Server can be accessed. It is only shown for reference and cannot be changed on this screen. To change the IP address (only if needed) it is necessary to use the Device Installer software that was included in your documentation package. (xxx.xxx.x.xxx)
2	Primary DNS Server	Domain Name System (DNS) servers help route your computer to appropriate locations. The Primary DNS server should be automatically detected when the web server is initialized. If it has been detected the IP address for the Primary DNS Server will appear in the box. If it does not appear it can be typed in. (xxx.xxx.x.xxx)
3	Secondary DNS Server	Domain Name System (DNS) servers help route your computer to appropriate locations. The Secondary DNS server should be automatically detected when the web server is initialized. If it has been detected the IP address for the Secondary DNS Server will appear in the box. If it does not appear it can be typed in. (xxx.xxx.x.xxx)
4	Default Gateway	This is generally the IP address for a firewall. Many Networks place a firewall between the network and the outside world. If the web server is behind a firewall it will be necessary to place the IP address for the firewall here. (xxx.xxx.x.xxx)

Table 4 (cont.)

Bullet	Item	Description
5	Overriding Domain	The Overriding Domain is used to forge the sender Domain Name in the outgoing Email message. This might be necessary, for example, if this device is located behind a firewall whose IP Address resolves to a different Domain Name than this device. For SPAM protection, many SMTP servers perform reverse lookups on the sender IP Address to ensure the Email message is really from who it says it's from.
6	Server Port	Every service on an Internet server listens on a particular port number on that server. Most services have a standard port (25). This port is used in conjunction with the "Overriding Domain"
7	SET button	Clicking this button will save any new values entered into the screen fields. If a value entered in one of the fields is an invalid number a pop up will be displayed directing that the value be corrected.
8	CANCEL button	This button brings the user back to the email screen.

ACCESSING WEB SERVER FROM EXTERNAL SOURCES

The web server is capable of emailing to any location that has a valid email address. However, if there is a need to view or configure the web server from outside the Local Area Network the network will have to be configured to allow this to happen. Most networks are protected through a firewall to prevent unauthorized access. Gaining access from external sources will require setting up a Port. A port can be configured with or without the need for a password. Setting up remote access requires the knowledge of a competent LAN Administrator.

TROUBLESHOOTING

GENERAL GUIDELINES.

The web server will refresh itself automatically every 4-5 minutes. If the Generator Backup System captures an “event” it will send this information to the web server immediately. However, there is some latency between what might be observed on the Generator Backup System front panel and the web server screen. This is normal and is not a problem with the product.

Table 5

Symptom	Possible Cause	Possible Solution
The web server extends beyond the top & bottom of the screen.	<ul style="list-style-type: none"> • Incorrect display resolution setting 	<ul style="list-style-type: none"> • Check the display resolution of the Computer. Minimum display resolution should be 1024 x 768 • Try F11. This will remove the header & footer sections of your web browser. F11 toggles full screen ON and OFF. Press again to return to normal screen.
Web server is not loading on the screen.	<ul style="list-style-type: none"> • No power to the Generator Backup System • Ethernet Cable not connected or bad cable • Incorrect IP address may be selected for the device. 	<ul style="list-style-type: none"> • Check power to Generator Backup System • Cycle power to Generator Backup System on and off • Check that RJ-45 connection is made. If so, replace cable if defective. • Check that correct IP address is entered in your web browser.
Web server will not email	<ul style="list-style-type: none"> • Incorrect email address entered • The Primary and Secondary DNS Servers, Default Gateway, Overriding Domain, or Server Port may be incorrect. 	<ul style="list-style-type: none"> • Verify that the email address entered is valid. • Verify with LAN Administrator that the Primary Server, Overriding domain and Port values are correct

CONFIGURATION DATA

Enter information for the Generator Backup System below for future reference

Internal IP Address: _____

External IP Address*: _____

Primary DNS Server: _____

Secondary DNS Server: _____

Default Gateway: _____

Overriding Domain: _____

Server Port: _____

* - This is the address that would need to be entered to gain access to the device from outside the local network.

WARRANTY INFORMATION

This equipment is sold by CONTROLS CORPORATION OF AMERICA under the warranties set forth in the following paragraphs. Such warranties are extended only with respect to the purchase of this equipment directly from CONTROLS CORPORATION OF AMERICA or its Authorized Distributors as new merchandise and are extended to the first Buyer thereof other than for the purpose of resale.

For a period of one (1) year from the date of original delivery (90 days in corrosive service) to Buyer or to Buyer's order, this equipment is warranted to be free from functional defects in materials and workmanship and to conform to the description of this equipment contained in this manual and any accompanying labels and/or inserts, provided that the same is properly operated under conditions of normal use and that regular periodic maintenance and service is performed or replacements made in accordance with the instructions provided. The foregoing warranties shall not apply if the equipment has been repaired: other than by CONTROLS CORPORATION OF AMERICA or a designated service facility or in accordance with written instructions provided by CONTROLS CORPORATION OF AMERICA, or altered by anyone other than CONTROLS CORPORATION OF AMERICA, or if the equipment has been subject to abuse, misuse, negligence or accident.

CONTROLS CORPORATION OF AMERICA's sole and exclusive obligation and Buyer's sole and exclusive remedy under the above warranties is limited to repairing or replacing, free of charge, at CONTROLS CORPORATION OF AMERICA's option, the equipment or part, which is reported to its Authorized Distributor from whom purchased, and which if so advised, is returned with a statement of the observed deficiency, and proof of purchase of equipment or part not later than seven (7) days after the expiration date of the applicable warranty, to the nearest designated service facility during normal business hours, transportation charges prepaid, and which upon examination, is found not to comply with the above warranties. Return trip transportation charges for the equipment or part shall be paid by Buyer.

CONTROLS CORPORATION OF AMERICA SHALL NOT BE OTHERWISE LIABLE FOR ANY DAMAGES INCLUDING BUT NOT LIMITED TO: INCIDENTAL DAMAGES, CONSEQUENTIAL DAMAGES, OR SPECIAL DAMAGES, WHETHER SUCH DAMAGES RESULT FROM NEGLIGENCE, BREACH OF WARRANTY OR OTHERWISE.

THERE ARE NO EXPRESS OR IMPLIED WARRANTIES WHICH EXTEND BEYOND THE WARRANTIES HEREINABOVE SET FORTH. CONTROLS CORPORATION OF AMERICA MAKES NO WARRANTY OF MERCHANTABILITY OR FITNESS FOR A PARTICULAR PURPOSE WITH RESPECT TO THE EQUIPMENT OR PARTS THEREOF.



ADI 9523-A

Certified ISO 9001:2000

Controls Corporation of America

1501 Harpers Road Virginia Beach, VA 23454

Telephone 1-800-225-0473 or 757-422-8330 • Fax 757-422-3125

www.concoa.com