



542 Series Generator Backup System

INSTALLATION AND OPERATING INSTRUCTIONS

Carefully Read These Instructions Before Operating

Controls Corporation of America
1501 Harpers Road · Virginia Beach, VA 23454
To Order Call 1-800-225-0473 or 757-422-8330 · Fax 757-422-3125
www.concoa.com
August 2019

THIS PAGE INTENTIONALLY LEFT BLANK

Contents

SAFETY	1
USER RESPONSIBILITY	3
DESCRIPTION OF PRODUCT.....	3
FEATURES	3
Settable Inlet Alarm Pressure.....	3
Settable Setpoint Pressure.....	3
Deadband	3
Hysteresis.....	4
Selectable Units of Measure	4
Alarm Notification	4
Ethernet Port – Web Server	4
Serial Port.....	4
INSTALLING THE GENERATOR BACK UP SYSTEM.....	6
SETTING DELIVERY REGULATOR PRESSURE.....	7
SETTING ALARM TRIP POINT PRESSURE	8
Attaching Altos 2 Pressure Monitor	10
SETTING SET POINT PRESSURE	10
SYSTEM TEST	13
OPERATING THE GENERATOR BACKUP SYSTEM.....	13
HOW IT WORKS.....	13
SETTING UNITS OF MEASURE.....	15
Generator Backup System Units of Measure.....	15
Altos 2 Pressure Transducer Assembly Units of Measure.....	15
ENABLING REMOTE SETUP	16
ENABLING/DISABLING LOCAL ALARM.....	17
Generator Backup Alarm	17
Altos 2 Pressure Monitor Alarm	17
SETTING COMMUNICATION MODE	18
CONNECTING ALARM OUTPUTS	19
CONFIGURING ALARM RELAY JUMPER.....	20
CONNECTING THE WEB SERVER.....	22
TROUBLESHOOTING.....	23
PERFORMING SELF TEST.....	24
MOUNTING DETAIL	26
POWER REQUIREMENTS.....	27
ACCESSORIES.....	27
SERVICE.....	28
WARRANTY INFORMATION	29
NOTES.....	30

SAFETY

THIS PRODUCT IS NOT INTENDED FOR USE WITH TOXIC GASES, FLAMMABLE GASES OR CORROSIVE GASES.

NOTICE

The 542 Generator Backup System is not intended for use in medical installations.



Basic safety precautions must be followed to reduce the risk of fire, electrical shock or injury.

- Connect the 542 Generator Backup System to the correct line voltage. A label on the product identifies what voltage it is wired for. **CONNECTION TO AN INCORRECT VOLTAGE CAN CAUSE SERIOUS DAMAGE TO THE PRODUCT AND WILL VOID ANY WARRANTY.**
- Install the 542 Generator Backup System
- where the ambient temperature range is between 0° F and 140° F.
- Do not install this product in a hazardous environment.
- If product appears damaged in any way, do not use and request service from CONCOA.
- Consult the cylinder distributor for the proper use of cylinders and for any restrictions on their use (such as flow rate and temperature requirements).
- Store cylinders with valve caps screwed on, and chain cylinders to a supporting wall or column.
- Handle cylinders carefully and only with valve caps screwed on. The cap will reduce the chance that the cylinder valve will break off if the cylinder is accidentally dropped or falls over. The cap also protects the cylinder valve from damage to screw threads, which could cause leaky connections.
- No smoking should be permitted near oxygen, nitrous oxide, any other oxidizer, flammable gases, or flammable mixtures, or in areas where cylinders are stored.
- Where an oxidizer (such as nitrous oxide or oxygen) is used, the manifold and cylinders must be kept clean. No oil, grease, or combustible substances should come in contact with oxygen or nitrous oxide storage or handling equipment. Such materials in contact with oxygen or nitrous oxide are readily ignitable and, when ignited, will burn intensely.
- Never lift gas cylinders with a magnetic lifting device.
- Never use an open flame when leak testing.
- Always open valves slowly when high-pressure gases are being used.
- Always be sure that a cylinder contains the correct gas before connecting it to any manifold.

- Always leak-test any manifold or distribution pipeline before using.
- Always be sure that the gas in a pipeline is the correct gas for the intended use.

- Always close all cylinder valves before disconnecting cylinders from a manifold.
- Always remove all empty cylinders from a manifold before connecting full cylinders.
- Always test cylinders to be sure the cylinders are full before connecting to a manifold.

All gas distribution piping systems must meet the appropriate industrial standards for the intended service and must be thoroughly cleaned before using. For the United States, some applicable safety rules and precautions are listed below:

1. American National Standards Institute standard Z49.1, Safety in Welding and Cutting, American Welding Society, 2501 NW Seventh Street, Miami, Florida 33125
2. N.F.P.A. Standard 51, Oxygen-Fuel Gas systems for Welding and Cutting, N.F.P.A., 470 Atlantic Avenue, Boston, Massachusetts 02210
3. N.F.P.A. Standard 51B, Cutting and Welding Processes (same address as #2).
4. CONCOA publication ADE 872, Safety Precautions in Welding and Cutting.
5. Local Ordinances
6. O.S.H.A. Standard 29 CFR
7. C.G.A. Pamphlet C-4, American National Standard Method of Marking Portable Compressed Gas Containers to Identify the Material Contained.
8. C.G.A. Pamphlet G-4, Oxygen – Information on the properties, manufacture, transportation, storage, handling, and use of oxygen.
9. C.G.A. Pamphlet G-4.1, Equipment Cleaned for oxygen service.
10. C.G.A. Pamphlet G-4.4, Industrial Practices for Gaseous Oxygen Transmission and Distribution Piping Systems.
11. C.G.A. Pamphlet G-5, Hydrogen – Information on the properties, manufacture, transportation, storage, handling, and use of hydrogen.
12. C.G.A. Pamphlet G-6, Carbon Dioxide – Information on the properties, manufacture, transportation, storage, handling, and use of carbon dioxide.
13. C.G.A. Pamphlet G-6.1, Standard for Low Pressure Carbon Dioxide Systems at Consumer Sites.
14. C.G.A. Pamphlet P-1, Safe Handling of Compressed Gases in Containers.
15. C.G.A. Safety Bulletin SB-2, Oxygen Deficient Atmospheres.

C.G.A. Pamphlets can be obtained from the Compressed Gas Association, 1235 Jefferson Davis Highway, Arlington, VA 22202-3239, (703) 979-0900. Publications: (703) 979-4341. Fax: (703) 979-0134.

USER RESPONSIBILITY

This equipment will perform in conformity with the description contained in this manual and accompanying labels and/or inserts when installed, operated, maintained, and repaired in accordance with the instructions provided. This equipment must be checked periodically. Improperly working equipment should not be used. Parts that are broken, missing, worn, distorted or contaminated, should be replaced immediately. CONCOA recommends that a telephone or written request for service advice be made to CONCOA Customer Service in Virginia Beach, Virginia, PHONE: 1-800-225-0473, FAX: 1-757-422-3125, or E-MAIL: e-mail@concoa.com.

This equipment or any of its parts should not be altered without prior written approval by CONCOA. The user of this equipment shall have the sole responsibility for any malfunction that results from improper use, faulty maintenance, damage, improper repair, or alteration by anyone other than CONCOA or a service facility designated by CONCOA.

DESCRIPTION OF PRODUCT

The 542 Series Generator Backup System is designed to provide a reserve supply of gas to a Gas Generator unit should that unit fail or become unable to provide an adequate gas supply. If the gas generator becomes unable to provide an adequate gas supply to the application, the 542 Generator Backup System will automatically activate and supply gas to the system without interruption. When the generator system becomes capable again of supplying gas to the application the 542 Generator Backup System will automatically turn off.

The 542 Generator Backup System can be configured in the field for different inlet pressure alarm points as well as output set points. It provides a digital display of the inlet and outlet pressures. These pressures are displayed alternately on the 4 digit LED display. Pressure can be displayed in PSI, BAR, or MPA. The 542 Generator Backup System can communicate to remote devices through an optional Web Server. In addition, the 542 Generator Backup System offers a connection to interface with CONCOA alarms or an optional built in audible alarm.

Figure 1 provides an explanation of the display panel and the inputs and outputs.

FEATURES

Settable Inlet Alarm Pressure

The 542 Generator Backup System can be configured to activate an alarm notification at pressures ranging from 500 to 2300 PSI in 120 PSI increments. This value is factory set but can be changed in the field. To change this value, refer to the section on changing the *Inlet Alarm Pressure Value*.

Settable Setpoint Pressure

The Setpoint or point at which the 542 Generator Backup System turns ON to provide gas is controlled by the Altos 2 Pressure Monitor. Refer to the section “Changing the Setpoint Pressure” in this manual.

Deadband

Once switching to the backup source from the Setpoint Pressure, the system can switch back once the main source pressure has risen by the deadband amount which is configurable in the Altos 2 Pressure Monitor. This prevents the system from “dithering” back and forth between the primary and backup sources.

Hysteresis

The 542 Generator Backup System has a built in feature called Hysteresis that prevents the system from “dithering” the backup low pressure alarm around an inlet alarm trip point. For the Inlet pressure this value is factory set at 10 PSI. What this means, as an example, is if the *inlet alarm pressure* value is set to 500 PSI the system will alarm at 500 PSI but the alarm will not clear until the inlet pressure builds back to 500 PSI plus Hysteresis (10 PSI) or 510 PSI.

Selectable Units of Measure

The default units of measure for the 542 Generator Backup System as well as the Altos 2 Pressure Monitor System are PSI. Alternate units of BAR or MPA can be selected. To change units of measure refer to the section on changing *units of measure*.

Alarm Notification

The 542 Generator Backup System is designed to interface with CONCOA Remote Alarms and comes with the necessary mating connector for their use. Refer to the section on *Connecting a Remote Alarm* for more information. There are effectively two alarm notifications. The first alarm occurs when the inlet pressure to the 542 Generator Backup System drops below the inlet alarm trip point. When this condition occurs, the red “Replace” light on the control panel will light and a relay will activate. This relay has a set of Normally Closed (N.C.) contacts which are accessible on the 4 pin circular connector labeled “Alarm Outputs” on the bottom of the unit. The second alarm occurs when the 542 Generator Backup System activates or is “In-Use”, normally because the primary source has dropped below the Pressure Setpoint. When this condition occurs the Green “In-Use” light will light on the control panel and a relay will activate. This relay has a set of Normally Closed (N.C.) contacts. These contacts are also accessible on the 4 pin circular connector labeled “Alarm Outputs” on the bottom of the unit.

Ethernet Port – Web Server

The 542 Generator Backup System may be equipped with an optional Web Server allowing for remote monitoring of functions, e-mailing, and remote configuration. For more information on the Web Server Option contact CONCOA Customer Service at 1 800 225-0473.

Serial Port

The 542 Generator Backup System is capable of communicating to peripheral equipment via a configurable serial port. For more information on the serial port refer to the section on *Setting Communication Mode* in this manual.

Figure 1

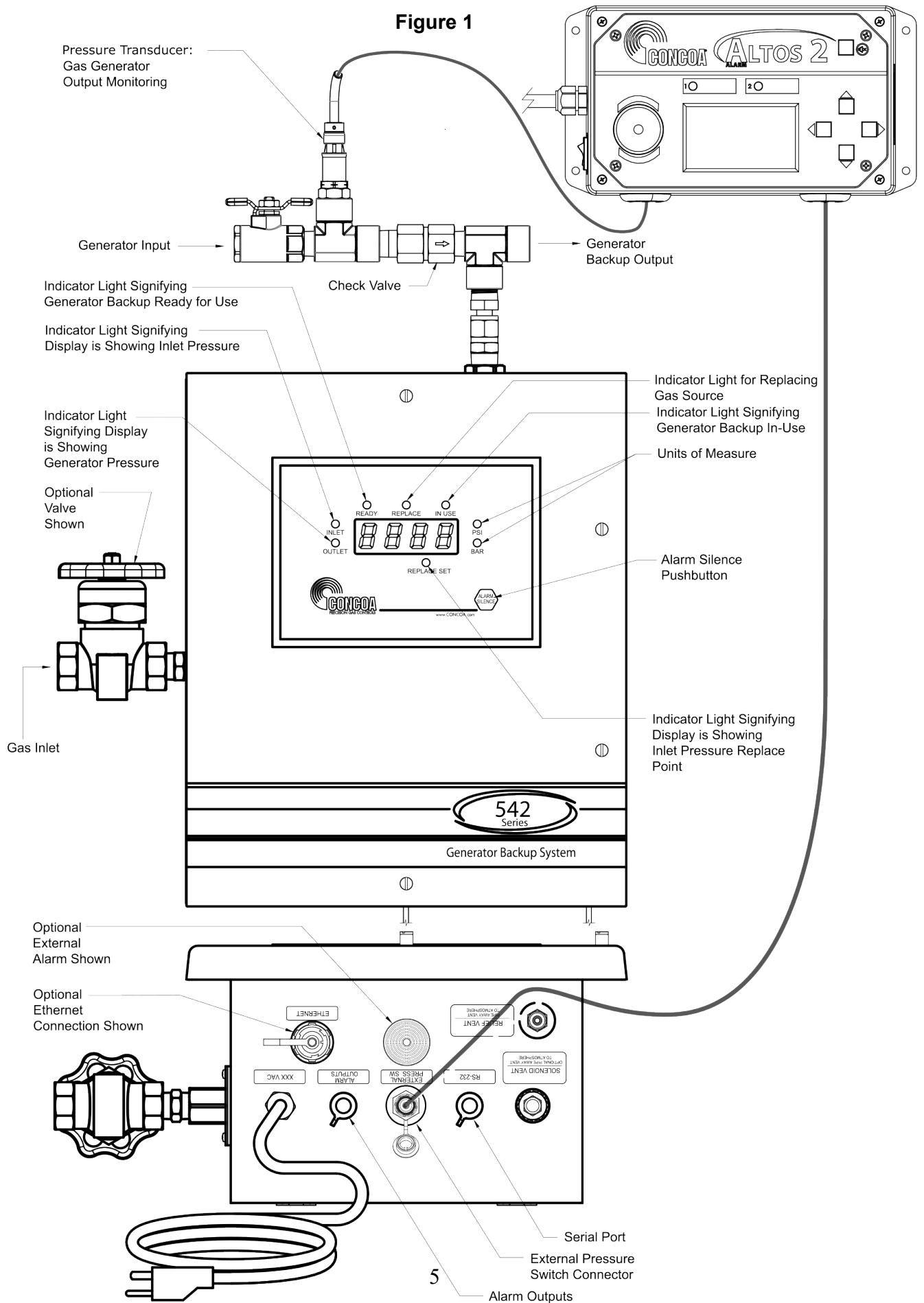

INSTALLING THE GENERATOR BACK UP SYSTEM

Understanding the application and sizing the components properly is the key to any successful system installation. Figure 2 shows a typical installation.

Figure 2

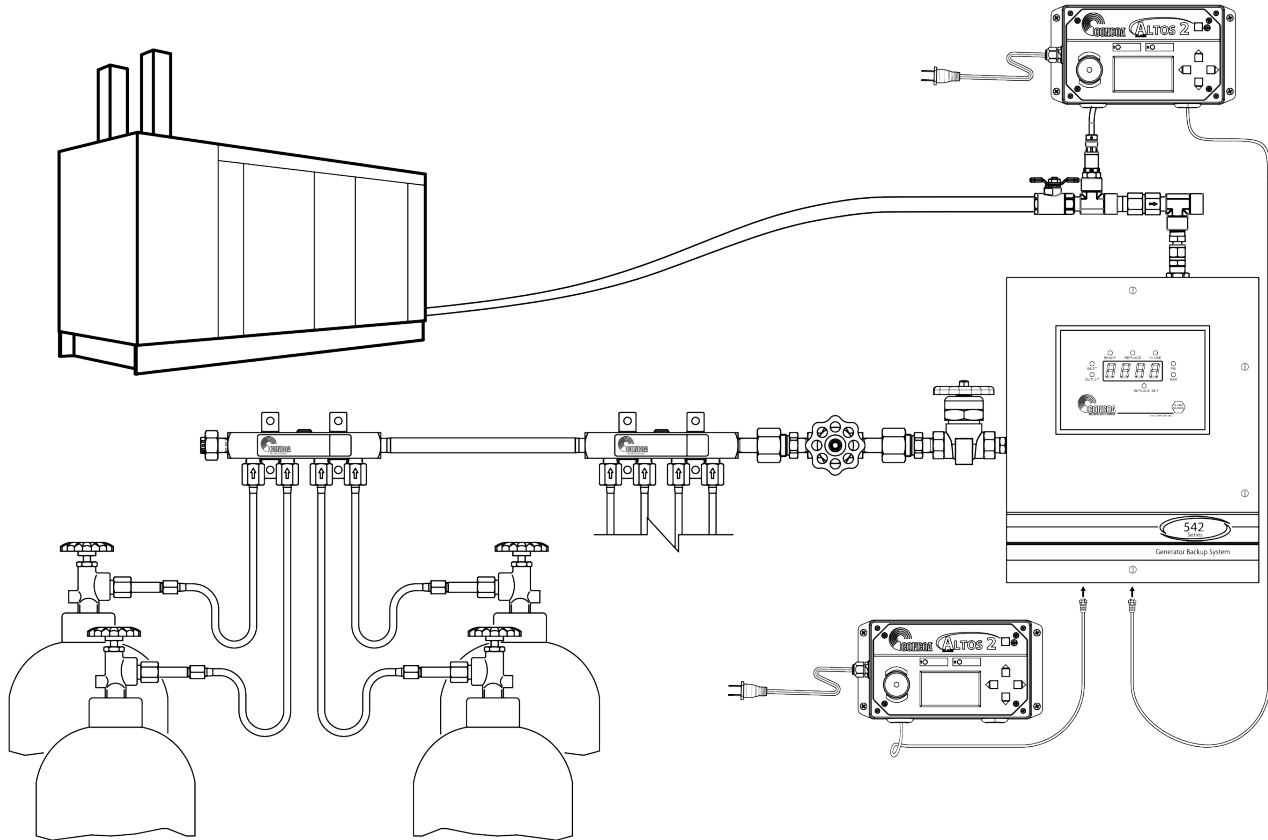

The inlet and outlet on the 542 Generator Backup System are 1/2" Female NPT fittings. **It is strongly recommended that two wrenches be used when tightening external devices to these fittings.**

1. The 542 Generator Backup System uses four mounting tabs for mounting to a wall or panel. Refer to Figure 12 at the back of this manual for the dimensions of the system. Anchor the 542 Generator Backup System securely to a wall or panel at a height adequate to conveniently connect a manifold or pigtail. **THE HEIGHT SELECTED MUST MEET ALL REGULATORY REQUIREMENTS.**
2. Install the Pressure transducer assembly to the 1/2" FNPT fitting at the top of the system making sure all mechanical connections are tight.
3. Follow instructions listed in the following section titled "Attaching Altos 2 Pressure Monitor" to attach pressure transducer to Altos 2, and Altos 2 to the 542
4. Connect the gas source to the inlet of the Gas Generator Backup System
5. Connect the Generator Backup to the Generator at the output of the Pressure Transducer Assembly
6. Once all mechanical connections are made pressurize the system and check for leaks.
7. Connect a Remote Alarm (if used) to the 542 Generator Backup System.

8. Finally connect AC power to the 542 Generator Backup System. The system is factory set to operate at either 115VAC 60hz or 230 VAC 60hz. Check the product label for the product voltage. Connection of the 542 Generator Backup System to the incorrect input voltage will damage the product and void any warranty.

THERE IS NO ON/OFF POWER SWITCH FOR THE 542 GENERATOR BACKUP SYSTEM. The installer must provide any required power switching external to the product.

SETTING DELIVERY REGULATOR PRESSURE

This pressure can be set without applying power. When there is no power to the system, the outlet valve is ON allowing gas to flow.

The pressure out of the regulator must be set to match the requirements of the generator it is being connected to and the application. To prevent drawing gas from the 542 Generator Backup System prematurely the pressure setting for the external Pressure Transducer Assembly must be set BELOW the primary pressure setting of the gas generator.

Using an Allen wrench, turn the set screw on the 542 Generator Backup System regulator clockwise to increase pressure or counterclockwise to decrease the pressure. This pressure should be set while there is gas flowing from the unit.

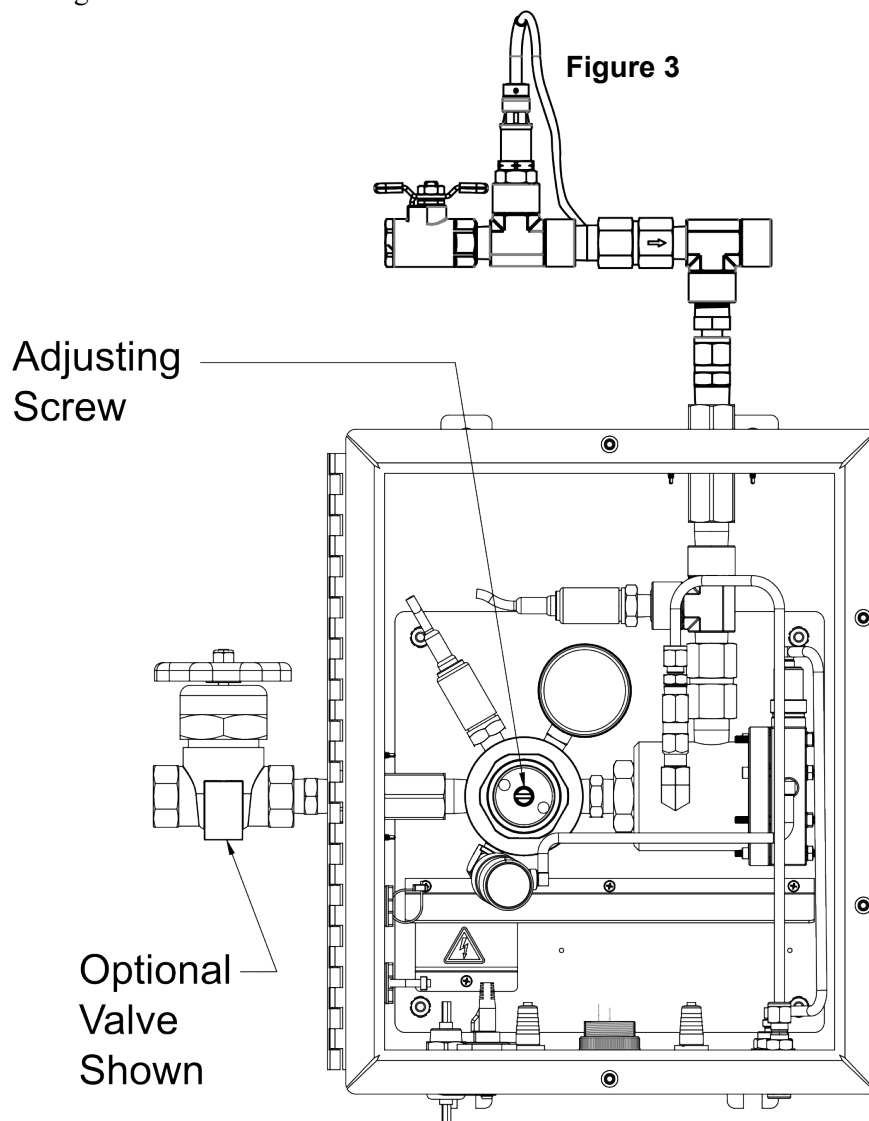

SETTING ALARM TRIP POINT PRESSURE

The alarm trip pressure point for the Generator Backup System is changeable within a range from 500 PSI to 2300 PSI. Each system has a specific alarm trip point pressure set at the factory based on the model ordered. There are four (4) DIP switches used to set this pressure. Table 1 shows a number that each switch represents. Each number adds 120 PSI to the trip point setting. This means that if the DIP switches are set to a value of 8 this would equal a PSI value of 960 PSI (8 x 120). Add this value to the minimum 500 PSI setting to yield a result of 1360 PSI.

To change the alarm trip pressure point from the factory set value, perform the following steps:

Note: In order for the DIP switches to be recognized, DIP switch SW4-1 must be OFF.

1. Turn power OFF to the system.
2. Open door by loosening the four screws holding it to the cabinet.
3. Using Figure 4, locate DIP switches SW2 at the bottom of the electronic circuit board on the door.

Figure 4

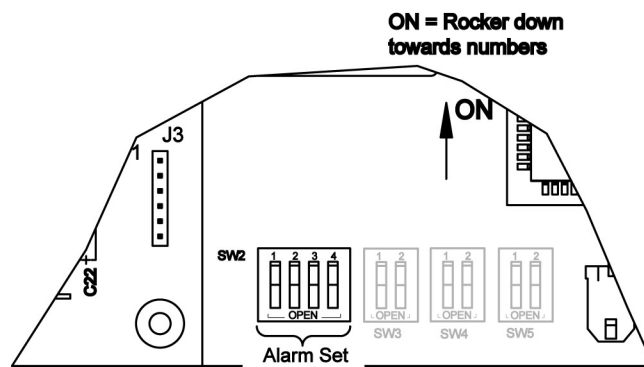

4. Referencing Table 1 or Table 2, set the desired switchover pressure.
5. Close system door and tighten 4 screws holding door to cabinet.
6. Turn power back ON. The new alarm trip pressure will take effect on power ON.

Table 1 — DIP Switch Settings

SWITCH	VALUE
SW2-1	120
SW2-2	240
SW2-3	480
SW2-4	960

Note: Tables 1 & 2 show values in PSI. If operating in BAR or MPA it will be necessary to convert from those units to PSI units in order to use the tables. To convert values from BAR to PSI multiply the BAR value by 14.5. To convert values from MPA to PSI multiply the MPA value by 145.

Table 2
Typical Alarm Trip Pressure DIP Switch Settings

PSI	SW2-1	SW2-2	SW2-3	SW2-4
500	OFF	OFF	OFF	OFF
620	ON	OFF	OFF	OFF
740	OFF	ON	OFF	OFF
860	ON	ON	OFF	OFF
980	OFF	OFF	ON	OFF
1100	ON	OFF	ON	OFF
1220	OFF	ON	ON	OFF
1340	ON	ON	ON	OFF
1460	OFF	OFF	OFF	ON
1580	ON	OFF	OFF	ON
1700	OFF	ON	OFF	ON
1820	ON	ON	OFF	ON
1940	OFF	OFF	ON	ON
2060	ON	OFF	ON	ON
2180	OFF	ON	ON	ON
2300	ON	ON	ON	ON

Attaching Altos 2 Pressure Monitor

The Altos 2 and pressure transducer act as a pressure switch for the 542 generator backup. First connect the cables as follows.

- Poke a hole through the middle of both rubber bulkhead plugs using a screwdriver.
- Note that the two below cables will crisscross inside the Altos 2 in order to provide some strain relief.
- Press the pressure transducer cable through the Altos 2 right plug. Tie a knot in the cable leaving 8" to prevent it from being pulled back out. Strip the ends and insert:
 - Red wire into "IN XDCR A +"
 - Black wire into "IN XDCR A -"
- Press the 542 backup generator pressure switch cable through the Altos 2 left plug. Tie a knot in the cable leaving 8" to prevent it from being pulled back out. Strip the ends and insert:
 - Black wire into "COM ALARM LEFT"
 - Red wire into Normally Closed side of switch labeled "NC ALARM LEFT"

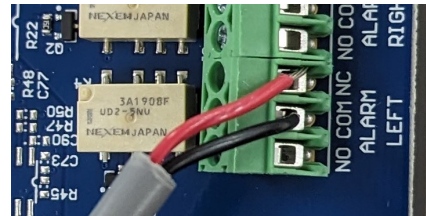
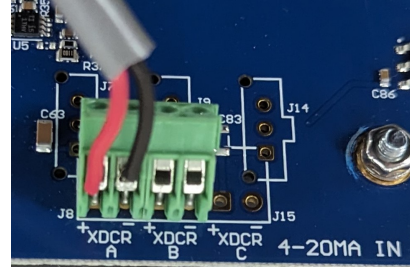

SETTING SET POINT PRESSURE

The set point is the pressure at which the Generator Backup System switches to the backup gas supply. The Altos 2 has a default setting of 500 PSIG, and must be changed for Generator Backup use. Therefore this pressure must be set during installation of the system. Typical values are shown in this table

542 outlet regulator range	Example Generator outlet pressure	Typical Altos 2 pressure set point (80% of outlet)	Typical Altos 2 Deadband (20% of outlet)
0-120 PSIG	100 PSIG	80 PSIG	20 PSIG
0-250 PSIG	200 PSIG	160 PSIG	40 PSIG

On the Altos 2:

- Disable Channel 2 since it will not be used.
 - Press Right arrow to enter menus.
 - Press Down arrow to pick Channel 2, and press right arrow to accept.
 - Press Right arrow to enter "Input/Alarm"
 - Press Down arrow to select "Input Disabled" and press right arrow to accept.
- Set Channel 1 max value. This should match the pressure of the attached transducer, 1000 PSI.
 - Press Right arrow to enter menus.
 - Press Down Arrow to select "System", then right arrow to accept.
 - Press Down Arrow to select "Set Ch 1 Max" and right arrow to accept.
 - Set to 1000 PSI
 - Left/Right arrow to change digits
 - Up/Down arrow to change value
 - Right arrow when on the right digit to save value.

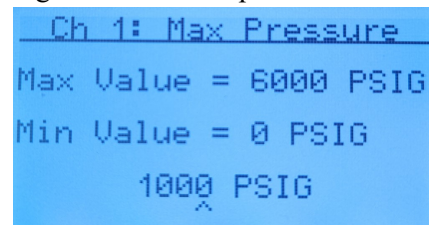
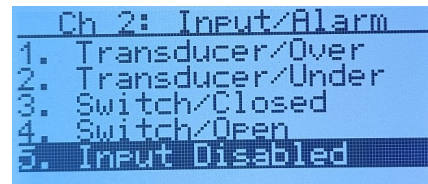

- Set Channel 1 set point pressure, typically around 20% less than the outlet regulator pressure.
 - Press Right arrow to enter menus.
 - Press right arrow to accept “Channel 1”.
 - Press Right arrow to enter “Input/Alarm”
 - Press Down arrow to pick “Transducer Under” and press right arrow to accept.
 - Press Right arrow to enter menus again.
 - Press right arrow to accept “Channel 1”.
 - Press Down arrow to pick “Alarm Set Point.”
 - Set to desired pressure
 - Left/Right arrow to change digits
 - Up/Down arrow to change value
 - Right arrow when on the right digit to save value.

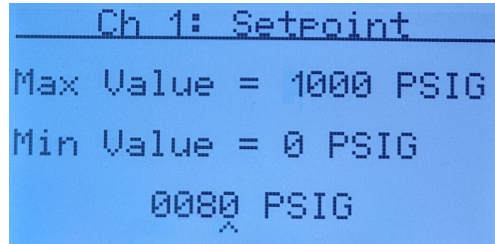

- Set Channel 1 deadband. After the above set point is reached, and backup supply is switched in. This value is how high above the Channel 1 set point should the system switch back to the primary supply. This prevents oscillating back and forth between the main and backup supplies. This value is typically 20% of the outlet regulator pressure,

- Press Right arrow to enter menus.
- Press Down Arrow to select “System”, then right arrow to accept.
- Press Down Arrow to select “Set Ch 1 Deadband” and right arrow to accept.
- Set to 20 PSI
 - Left/Right arrow to change digits
 - Up/Down arrow to change value
 - Right arrow when on the right digit to save value.

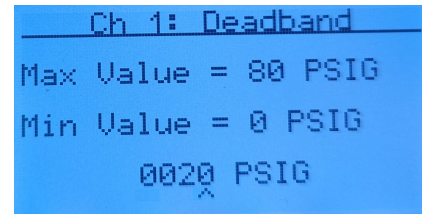

- Verify settings:
 - Confirm main screen shows “----“ for Channel 2.
 - Confirm main screen for Channel 1 shows:
 - ALARM UNDR 80 PSIG. (or value entered above).

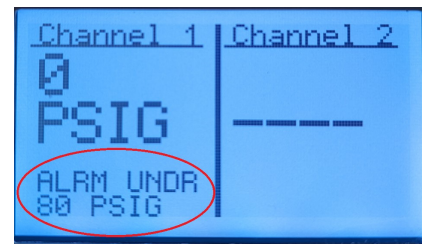
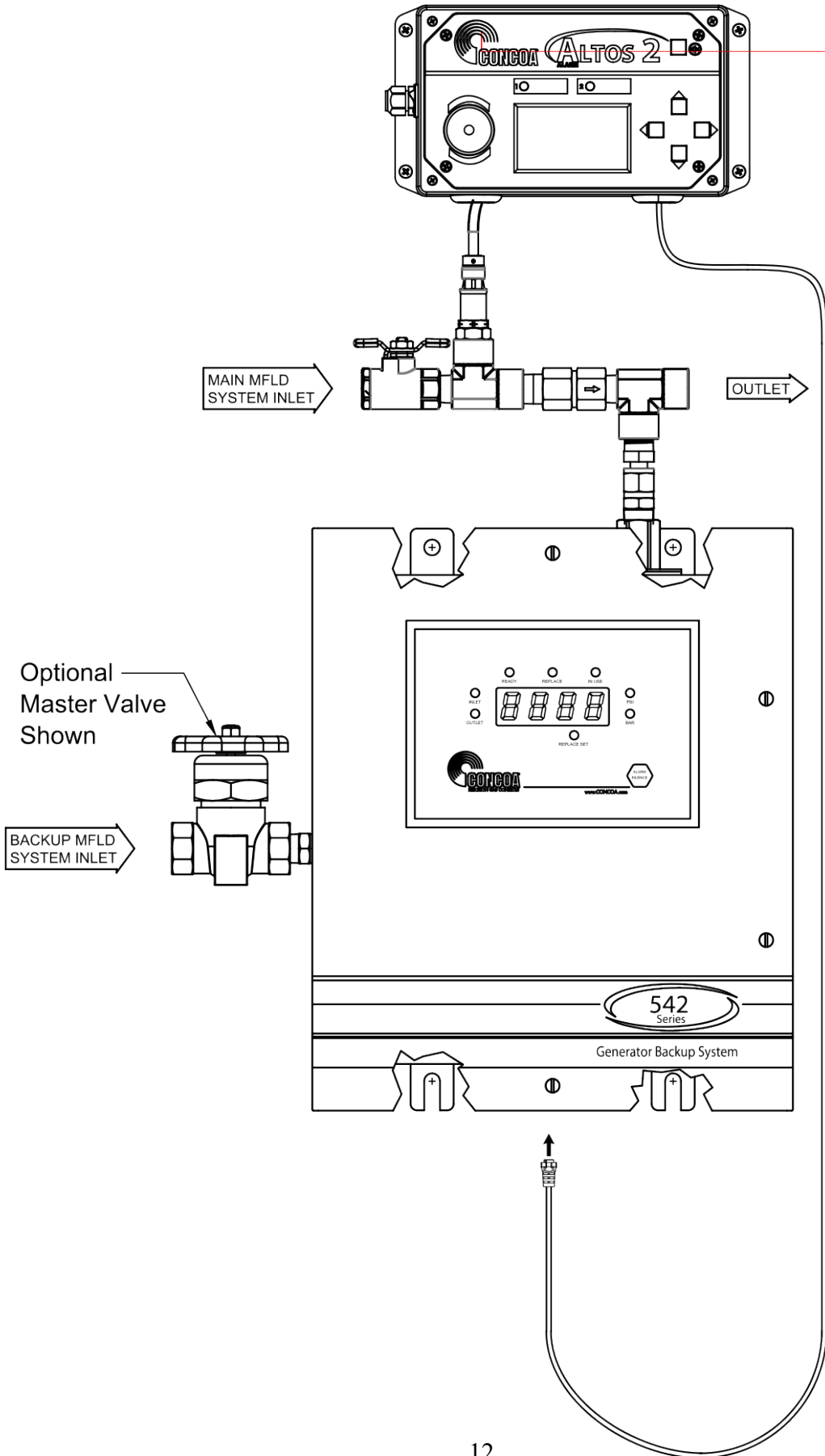

Figure 5



Comment
pressure tra

SYSTEM TEST

It is recommended that the system be tested before being placed into service.

9. With gas flowing to the application, reduce pressure or stop gas from flowing from the primary generator gas source so that the pressure drops below the pressure transducer setting. This should cause the Generator Backup System to turn on sourcing gas to the application. To test the inlet alarm trip point reduce the backup inlet pressure to the generator backup system until it drops below the trip point setting. The generator backup system should indicate an alarm condition. Increasing the backup inlet pressure should clear the alarm. Now increase the primary pressure from the generator and the generator backup system should turn off its gas supply to the application.

OPERATING THE GENERATOR BACKUP SYSTEM

Explanations in this section assume that an installer has properly mounted the 542 Generator Backup System to the wall, connected the inlet gas source, connected the outlet to the point if use, checked for leaks and connected power.

There are three minimum settings that must be made prior to using the 542 Generator Backup System.

1. Set Pressure Regulator
2. Set *Inlet Alarm Pressure* value (Replace Set)
3. Set Outlet Setpoint Pressure on the external Pressure Transducer Assembly

HOW IT WORKS

The 542 Generator Backup System control panel consists of a 4 digit display, 9 status lights and a pushbutton. The display is used to display both the inlet pressure and the Generator pressure. This is accomplished by alternating between the two pressures approximately every 3-4 seconds. There are two indicator lights to the left of the display that identify which pressure is being displayed. They are labeled INLET (pressure into the system) and OUTLET (pressure from the generator).

Above the 4 digit display are three indicator lights labeled “In-Use”, “Replace”, and “Ready”. The “Replace”, and “Ready” lights provide the status of the Inlet gas source. When the “Ready” light is ON it means that the inlet pressure is above the *inlet alarm pressure* value and ready for use. When the “Replace” light is ON it means that the inlet pressure has dropped below the *inlet alarm pressure* value and the inlet gas source should be replaced. A relay contact is switched when the “Replace” light turns ON. The relay contacts for this relay are brought out to the 4 pin circular connector at the bottom of the system. They are factory set such that they are Normally Closed (N.C.) when power is applied to the system. This means that they are closed during a “normal” condition and open when an alarm condition occurs. The “Replace” light will turn OFF when the pressure at the inlet increases above the inlet trip point plus the Hysteresis Value (typically 10 psi) and the Relay contacts for the inlet will close again (normal condition).

The “In-Use” light will light when the 542 Generator Backup System detects that the Generator pressure has dropped below the “Set point”. At the same time a set of relay contacts is switched when the “In-Use” light turns ON. The relay contacts for this relay are brought out to the 4 pin circular connector at the bottom of the system. They are factory set as Normally Closed (N.C.). This means that they are closed during a “normal” condition and open when the relay activates. The “In-Use” light will begin to flash when the Generator pressure builds back above the set point on the external Pressure Transducer

Assembly and the 542 Generator Backup System will shut off and allow the Generator primary source to take over. The “In-Use” Relay contacts will remain open until the “Alarm Silence” pushbutton is pressed. Once pressed, the relay contacts will close again (normal) and the “In-Use” light will stop flashing and turn OFF.

If the system should lose power both sets of contacts will open signifying a fault condition.

It is possible to check the Inlet Alarm Trip Point Pressure value at any time by entering the “Self Test Mode”. Refer to the “Performing Test Mode” section in this manual

SETTING UNITS OF MEASURE

The Generator Backup System can display pressure in three different units of measure, PSI, BAR, and MPA. The factory default is PSI. The Altos 2 Pressure Monitor Assembly should also be changed to match.

Generator Backup System Units of Measure

Note: In order for the DIP switches to be recognized, DIP switch SW4-1 must be OFF.

1. Turn AC power OFF to the system.
2. Open door by loosening the four screws holding it to the cabinet.
3. Using Figure 6, locate DIP switch SW2 at the bottom of the electronic circuit board on the door.
4. Referencing Table 3 set the appropriate units of measure.
5. Close system door and tighten 4 screws holding door to cabinet.
6. Turn AC power back ON. The new units of measure will take effect on power ON.
7. The indicator lights on the front panel show the units of measure selected. If the PSI and BAR indicator lights are OFF, the system is displaying MPA units.

Table 3

Units	SW3-1	SW3-2	
PSI	OFF	OFF	default
BAR	ON	OFF	
MPA	OFF	ON	

Figure 6

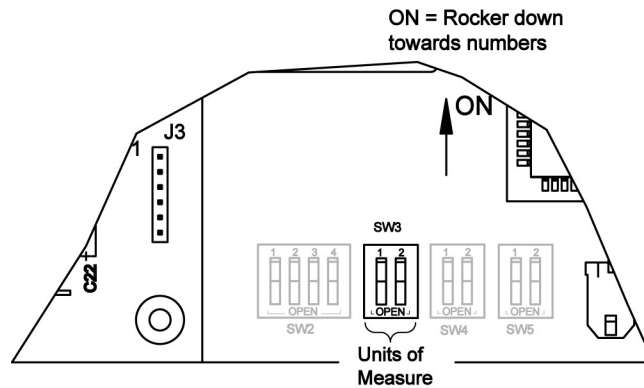

Altos 2 Pressure Transducer Assembly Units of Measure

8. Press Right arrow to enter menus.
9. Press Right Arrow to select "Channel 1"
10. Press Down arrow to select "Units of Measure" and Right arrow to accept.
11. Use Up/Down arrow to select desired units, then Right arrow to accept.

ENABLING REMOTE SETUP

The Generator Backup System is equipped with a feature that allows setting of system parameters remotely via the serial port or the optional Ethernet port. **FACTORY DEFAULT IS ON.** This feature **MUST** be enabled in order for the remote setup feature to work. To disable this feature perform the following steps:

1. Turn AC power OFF to the system.
2. Open door by loosening the four screws holding it to the cabinet.
3. Using Figure 7, locate DIP switch SW4-1 at the bottom of the electronic circuit board on the door.
4. Referencing Table 4 turn SW4-1 to the OFF position.
5. Close system door and tighten 4 screws holding door to cabinet.
6. Turn AC power back ON.

Note:

When this feature is enabled, system setup parameters are saved to internal memory in the control electronics. The DIP switches on the control board for these setup parameters will be ignored. To allow use of the setup parameter DIP switches on the control board, SW4-1 must be in the OFF position.

Figure 7

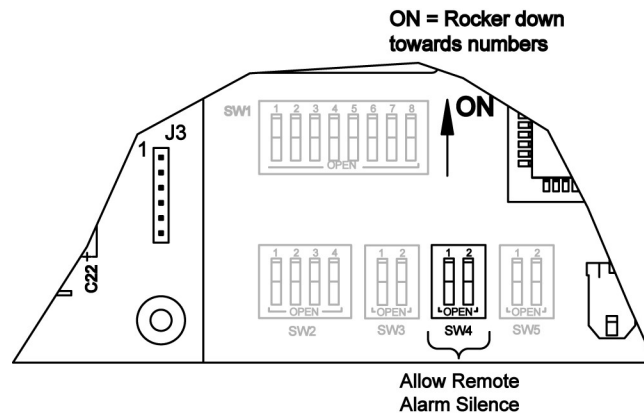

Table 4

Function	SW4-1	SW4-2
Allow Remote	ON	N/A

default

ENABLING/DISABLING LOCAL ALARM

Generator Backup Alarm

The Generator Backup System may be equipped with an optional local audible alarm. If this option is installed it is possible to disable this alarm through the use of a DIP switch on the electronic control board. If this option is included with the device it would be FACTORY SET to ENABLED. TO disable this feature:

7. Turn AC power OFF to the system.
8. Open door by loosening the four screws holding it to the cabinet.
9. Using Figure 7, locate DIP switch SW4-2 at the bottom of the electronic circuit board on the door.
10. Referencing Table 5 turn SW4-2 to the OFF position.
11. Close system door and tighten 4 screws holding door to cabinet.
12. Turn AC power back ON.

Table 5

Function	SW4-1	SW4-2
Alarm Silence	N/A	ON

default

Altos 2 Pressure Monitor Alarm

The Altos 2 Pressure Monitor Assembly comes by default with its local audible alarm enabled. If desired, this alarm can be silenced with internal dip switch SW5-1. To permanently silence the alarm, power down the unit, open the front cover, and flip SW5-1 off (open).

SETTING COMMUNICATION MODE

The Generator Backup System has the built in capability to communicate externally via the Ethernet (Web Server) or an RS-232 serial port. The factory default value is Ethernet (Web Server). To change the device from Ethernet to serial communication, follow the steps below.

1. Turn AC power OFF to the system.
2. Open door by loosening the four screws holding it to the cabinet.
3. Referencing Figure 8, locate DIP switch SW5 at the bottom of the electronic circuit board on the door.
4. Referencing Table 6 set the desired communication mode.
5. Close system door and tighten 4 screws holding door to cabinet.
6. Turn AC power back ON. The new communication mode will take effect on power ON.

Figure 8

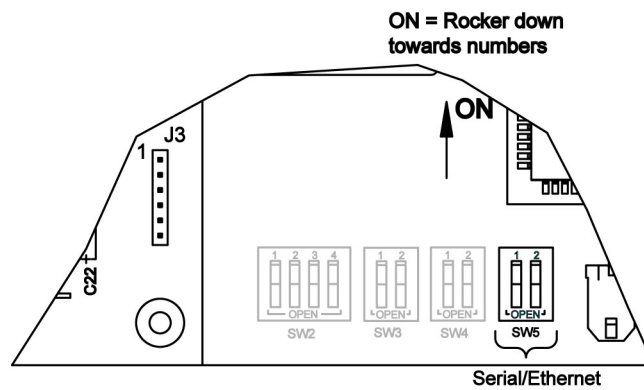

Table 6

Communication Mode	SW5-1	SW5-2	
RS-232	OFF	N/A	
Ethernet	ON	N/A	default

CONNECTING ALARM OUTPUTS

The 542 Generator Backup System provides an output signal corresponding to the low input pressure alarm condition that it senses. This signal is brought out to a 4 pin circular connector on the bottom of the unit. A mating 4 pin connector is provided to allow for connecting the Generator Backup System to an external alarm. Pre-made cables are also available (CONCOA part no. 5295320-L [L= cable length – contact CONCOA for available lengths]). Contact your local CONCOA Distributor or call 1-800-225-0473 for information. The switch is configured as Normally Closed (N.C.) which means that the switch opens on fault or alarm.

The recommended cable for making an output cable assembly is 22 AWG, 4-conductor stranded wire (Alpha # 1174C or equivalent). The length of this cable should be limited to 1500 feet.

Cut the 4-conductor cable to length. Remove the outer jacket of the cable to expose approximately 3/4 inch of the internal conductors on both sides of the cable. Strip away 1/4-inch of the insulation on each of the conductors.

On the 4-pin connector, slide the protective cover, cable retainer, and locking nut over the end of the cable as shown in Figure 9.

Using the pin assignments shown in Table 7 and the connector views in Figure 9 and Figure 10, solder the wires to the appropriate pins. After soldering is complete, slide the locking nut over the connector body. Snap the cable retainer into the body and then slide the protective cover over the cable retainer.

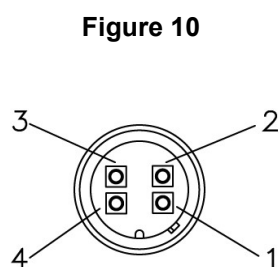
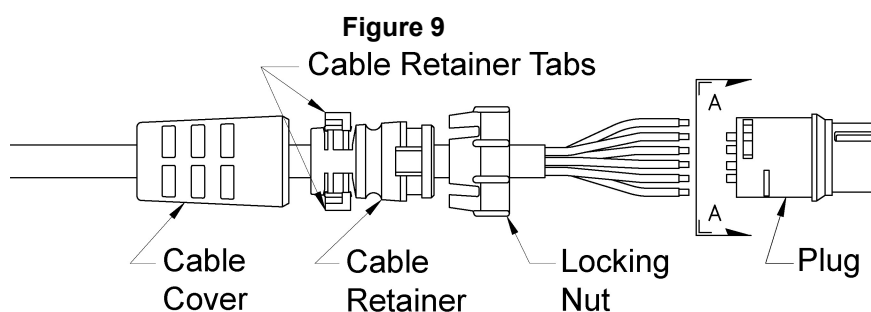

VIEW A-A

Table 7— Alarm Output Pin Assignments

Alarm Output Connector Pin Number	Function
1	Inlet Alarm
2	+V (external)
3	+V (external)
4	In-Use

CONFIGURING ALARM RELAY JUMPER

The Generator Backup System is designed to interface to an external alarm system. A Relay contact is brought out through a connector on the bottom of the cabinet. The pin connections on this connector are set to connect directly to a CONCOA alarm. CONCOA alarms are designed such that the contacts are Normally Closed (N.C.). In an alarm condition these contacts will open. This is the factory default. It is possible to change these contacts to Normal Open (N.O.). Figure 11 shows the location of the jumpers on the Control Board. To change a contact from N.C. to N.O. follow the steps below:

1. Turn AC Power OFF to the system
2. Open front door by loosening the 4 screws holding it to the cabinet.
3. Locate the jumpers on the Control Board.
4. Referencing Table 8 and Figure 11, set the jumpers.
5. Close door and re-secure it to the cabinet.
6. Make the necessary connections to the alarm and plug the alarm cable into the alarm connector on the bottom of the cabinet.
7. Turn AC power ON.
8. Test Mode may be used to test the alarm installation.

Table 8

Jumper	Function
J5	Alarm Output
J7	In-Use Output

Figure 11

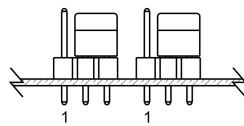
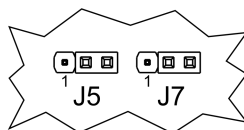
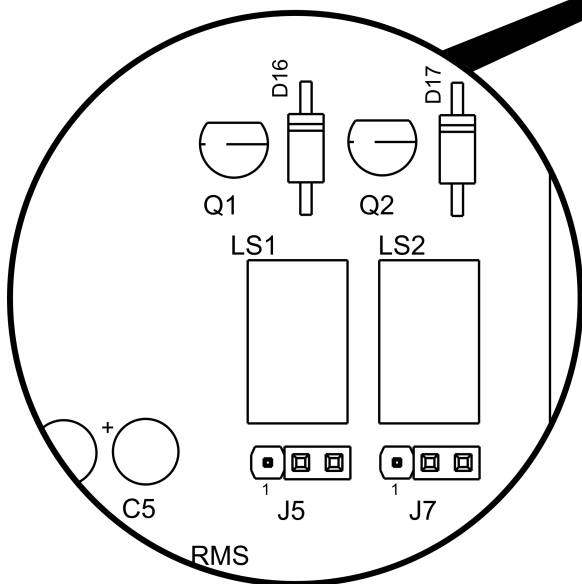
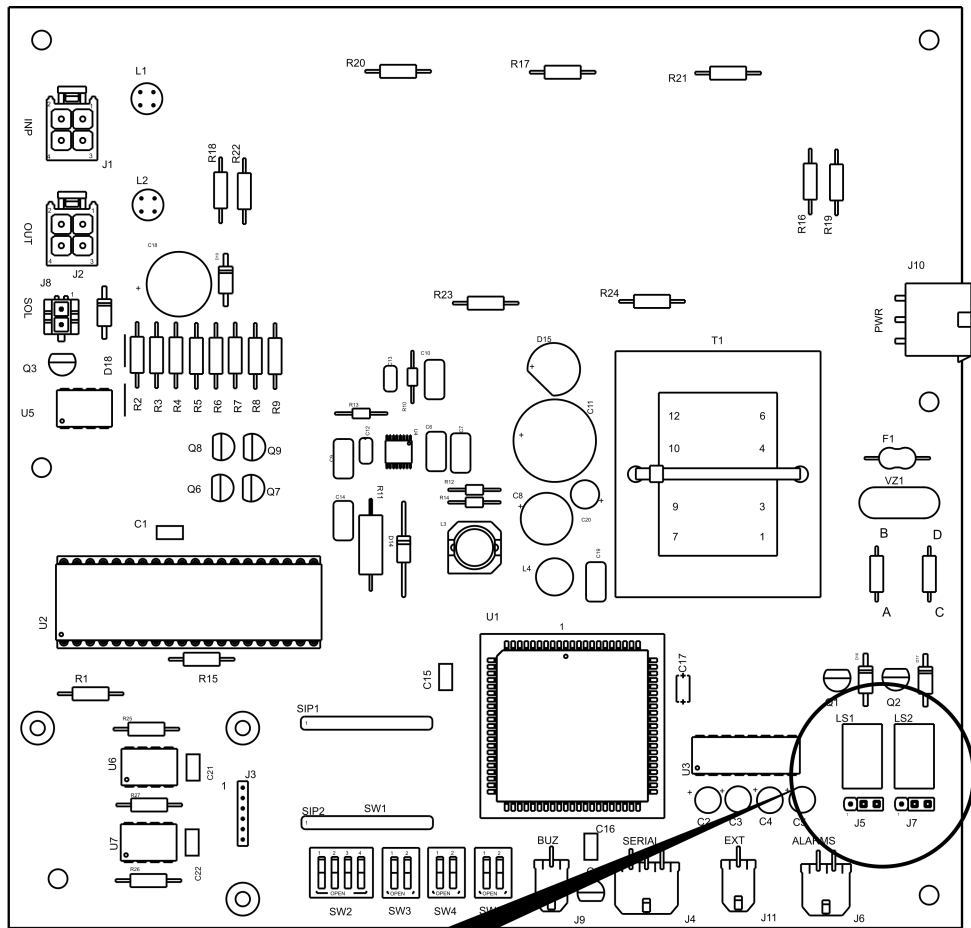

Jumpers in
Factory Default
Position:
Normally Closed

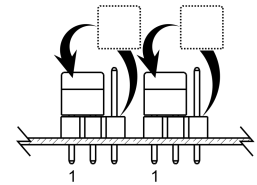
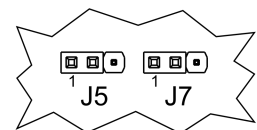

Jumpers
Moved to
Normally Open
Position

CONNECTING THE WEB SERVER

The 542 Generator Backup System may be equipped with an optional integral Web Server device. Connection to the Web Server is through an RJ45 connector located at the bottom of the Generator Backup System. Unscrew the protective cap that covers the connector jack to insert the cable. Connect any CAT 5 or CAT 6 cable to make this connection and connect the other end of the cable to the local area network. Refer to the User's Manual for the Web Server that was included with the Generator Backup System (if optionally equipped) for instructions on interfacing it to the local area network and for its operation.

TROUBLESHOOTING

Symptom	Possible Cause	Possible Solution
No display or status lights ON.	<ul style="list-style-type: none"> • No power to the system. • Check that the power source is live. • Check the system fuse. 	<ul style="list-style-type: none"> • Restore power. • Replace fuse. • Replace electronic control board.
System will not activate when the Generator loses pressure.	<ul style="list-style-type: none"> • Check that the setpoint pressure on the Altos 2 pressure monitor is set. • Outlet Valve from generator backup is OFF 	<ul style="list-style-type: none"> • Set appropriate pressure. • Turn Valve ON.
Display reads 0 PSI .	<ul style="list-style-type: none"> • Inlet Pressure valve is turned OFF 	<ul style="list-style-type: none"> • Turn Valves ON
Units of Measure are Incorrect	<ul style="list-style-type: none"> • Internal DIP switches not set correctly 	<ul style="list-style-type: none"> • Change units of measure DIP switches

PERFORMING SELF TEST

Through the use of the “Alarm Silence” button on the front panel, Test Mode can be accessed and a number of items can be observed or analyzed. TEST MODE CANNOT BE ACCESSED IF SYSTEM IS IN AN ALARM CONDITION (OR WITHOUT PRESSURE). To enter Test Mode press **TEST** old the “Alarm Silence” pushbutton on the front panel for 4 seconds. The system display will show the word test [] as it enters the Test Mode. Releasing the button begins the tests. A description of the tests follows.

START TEST

This display is an indication that the system has entered TEST mode. Releasing the pushbutton will move the display to Test 1.

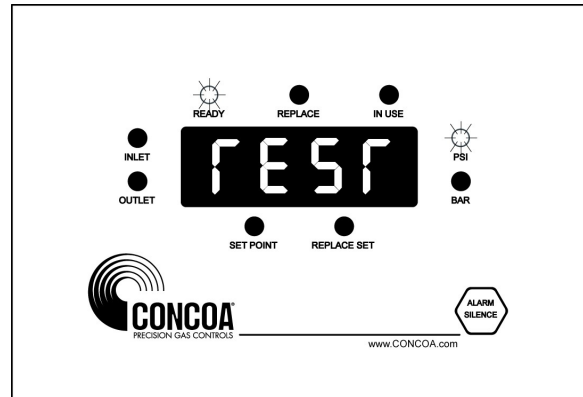

TEST 1 – DISPLAY TEST

This test activates each LED and each segment on the display to make sure that all LEDs and displays are functioning properly. It will continuously cycle until the pushbutton is pressed to move to the next test. Press the “Alarm Silence” pushbutton to move to the next test.

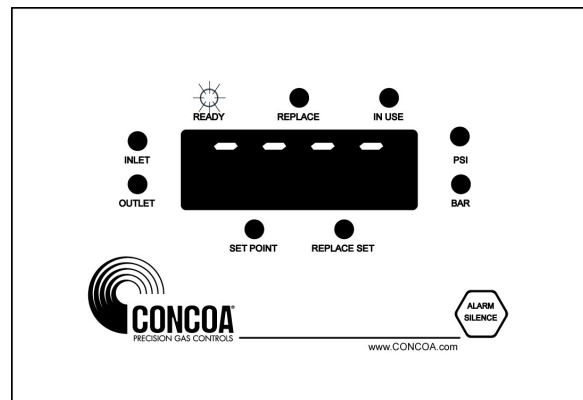

TEST 2 – REPLACE POINT SET

This shows the pressure in PSI at which the system will indicate an alarm condition signifying that cylinders feeding the system need replacement. Press the “Alarm Silence” pushbutton to move to the next test.



TEST 3 - SOFTWARE REVISION

This is the revision of the software running the product. Press the “Alarm Silence” pushbutton to exit Test Mode.

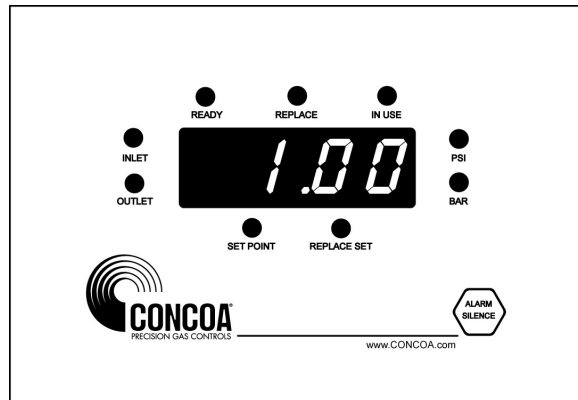

MOUNTING DETAIL

Figure 12

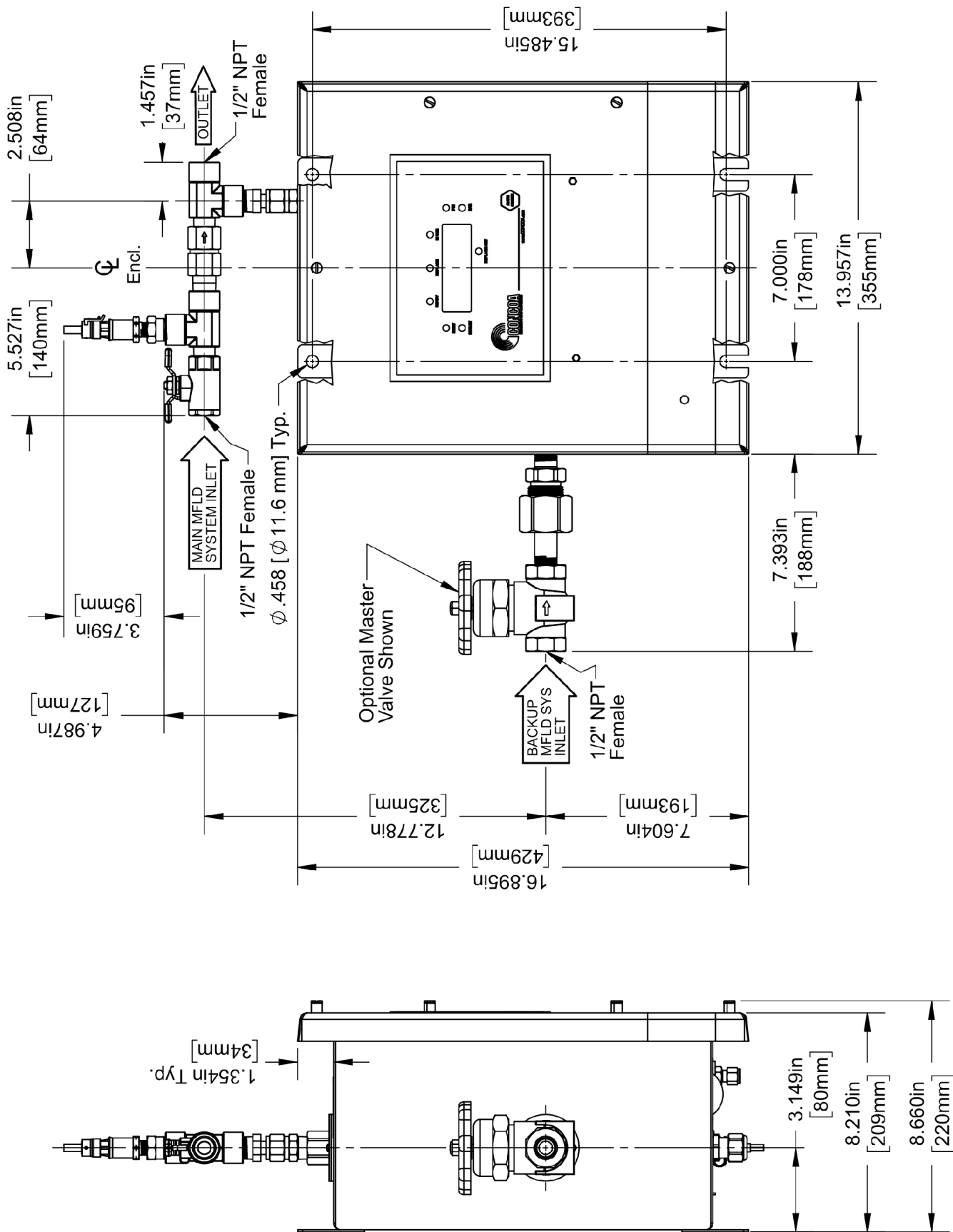

POWER REQUIREMENTS

Input Voltage: 115 VAC \pm 10% 50-60hz or 230 VAC \pm 10% 50-60hz

Power Consumption: 10 watts

The Operating Voltage for the 542 Generator Backup System is configured at the factory and cannot be modified in the field. Make sure that the product is connected to the correct input voltage as stated on the product labeling. Connection to an incorrect voltage will cause serious damage to the product.

FUSES; Type 3AG, 0.5amps 250v (Qty 2)

Weight: Approx 49lbs.

ACCESSORIES

Altos 2 Alarm – 120/220volt PN 5750025-01-000

Pre-Made Cable, 542 Series Generator Backup to Altos 2 Alarm
(4-Pin Female Circular Conn. x 4 Bare Wires) PN 5295320-L*

* “-L” in cable part number is the cable length. Contact CONCOA for available lengths.

SERVICE

GENERAL

A unit which is not functioning properly should not be used until all required repairs have been completed and the unit has been tested to ascertain that it is in proper operating condition.

CAUTION!

Inspection, troubleshooting, and repair of this equipment as indicated in this manual, should only be undertaken by a competent individual having at least general experience in the maintenance and repair of equipment of this nature.

Defective parts should not be replaced with either a replacement part manufactured or sold by CONCOA or an equivalent.

Except for inspection, troubleshooting, and repairs indicated in this manual, it is recommended that all servicing be done by a service facility authorized by CONCOA. Contact the CONCOA Customer Service Department in Virginia Beach or the nearest CONCOA District Sales Office for assistance.

If so advised, the unit should be sent to a service facility authorized by CONCOA, adequately packaged, in the original shipping container if possible, and shipped prepaid, with a statement of observed deficiency. The gas service that the equipment has been subjected to must be clearly identified. All equipment must be purged before shipment to protect the transporter and service personnel. The purging is especially important if the equipment has been in hazardous or corrosive gas service. Return trip transportation charges are to be paid by Buyer. In all cases other than where warranty is applicable, repairs will be made at current list price for the replacement part(s) plus a reasonable labor charge.

Test regulator for leaks on a routine schedule.

WARRANTY INFORMATION

This equipment is sold by CONTROLS CORPORATION OF AMERICA under the warranties set forth in the following paragraphs. Such warranties are extended only with respect to the purchase of this equipment directly from CONTROLS CORPORATION OF AMERICA or its Authorized Distributors as new merchandise and are extended to the first Buyer thereof other than for the purpose of resale.

For a period of one (1) year from the date of original delivery (90 days in corrosive service) to Buyer or to Buyer's order, this equipment is warranted to be free from functional defects in materials and workmanship and to conform to the description of this equipment contained in this manual and any accompanying labels and/or inserts, provided that the same is properly operated under conditions of normal use and that regular periodic maintenance and service is performed or replacements made in accordance with the instructions provided. The foregoing warranties shall not apply if the equipment has been repaired: other than by CONTROLS CORPORATION OF AMERICA or a designated service facility or in accordance with written instructions provided by CONTROLS CORPORATION OF AMERICA, or altered by anyone other than CONTROLS CORPORATION OF AMERICA, or if the equipment has been subject to abuse, misuse, negligence or accident.

CONTROLS CORPORATION OF AMERICA's sole and exclusive obligation and Buyer's sole and exclusive remedy under the above warranties is limited to repairing or replacing, free of charge, at CONTROLS CORPORATION OF AMERICA's option, the equipment or part, which is reported to its Authorized Distributor from whom purchased, and which if so advised, is returned with a statement of the observed deficiency, and proof of purchase of equipment or part not later than seven (7) days after the expiration date of the applicable warranty, to the nearest designated service facility during normal business hours, transportation charges prepaid, and which upon examination, is found not to comply with the above warranties. Return trip transportation charges for the equipment or part shall be paid by Buyer.

CONTROLS CORPORATION OF AMERICA SHALL NOT BE OTHERWISE LIABLE FOR ANY DAMAGES INCLUDING BUT NOT LIMITED TO: INCIDENTAL DAMAGES, CONSEQUENTIAL DAMAGES, OR SPECIAL DAMAGES, WHETHER SUCH DAMAGES RESULT FROM NEGLIGENCE, BREACH OF WARRANTY OR OTHERWISE.

THERE ARE NO EXPRESSED OR IMPLIED WARRANTIES WHICH EXTEND BEYOND THE WARRANTIES HEREINABOVE SET FORTH. CONTROLS CORPORATION OF AMERICA MAKES NO WARRANTY OF MERCHANTABILITY OR FITNESS FOR A PARTICULAR PURPOSE WITH RESPECT TO THE EQUIPMENT OR PARTS THEREOF.



Certified ISO 9001:2000

Controls Corporation of America

1501 Harpers Road Virginia Beach, VA 23454

To Order Call 1-800-225-0473 or 757-422-8330 • Fax 757-422-3125

www.concoa.com