

**The 515 Series
SilcoNert[®] 2000
Treated Stainless
Steel Automatic
Switchover System
with Inlet Pressure
Transducers**

**For use with Ultra High
Purity, Corrosive and Toxic
Gases**







INSTALLATION AND OPERATION INSTRUCTIONS

Before Installing or Operating, Read and Comply with These Instructions

Controls Corporation of America
1501 Harpers Road Virginia Beach, VA 23454
To Order Call 1-800-225-0473 or 757-422-8330 • Fax 757-422-3125
www.concoa.com

DESCRIPTION OF PRODUCT

The 515 series switchover is an automatic switchover system designed to provide a continuous supply of high purity, corrosive and toxic gas. This unit is designed for use with one cylinder per side. The inlets of the switchover system may be purchased with open ports, diaphragm valves, or flexible pigtailed. If constant outlet pressure is required, a line regulator will need to be installed on the switchover outlet (see part number key at end of this document) or down-stream after the switchover system. If the system includes the optional remote alarm, refer to ADI 0025 for installation and operation instructions. The table below shows the switchover pressures for all models and the outlet pressures for models that do not include the integral line regulator option:

MODEL NUMBER	Switchover Pressure (Applicable to All Models)		Outlet Pressure for Models Without Integral Line Regulator
515 4x0x	Priority Knob Left 165-175 PSI (11.4-12.1 BAR) 	Priority Knob Right 230-245 PSI (15.9-16.9 BAR) 	165-245 PSIG (11.4-16.9 BAR)
515 5x0x	Priority Knob Left 455-475 PSI (31.4-32.8 BAR) 	Priority Knob Right 515-545 PSI (35.5-37.6 BAR) 	455-545 PSIG (31.4-37.6 BAR)
515 8x0x	Priority Knob Left 255-275 PSI (17.6-19.0 BAR) 	Priority Knob Right 315-345 PSI (21.7-23.8 BAR) 	255-345 PSIG (17.6-23.8 BAR)

Switchover systems with the integral line regulator option will maintain line pressure set by the user within the limits shown in the table below provided the selected switchover pressure is greater than the selected line regulator delivery pressure:

MODEL NUMBER	Line Regulator Delivery Pressure	
515 XX1X	0-15 PSIG	0-1 BAR
515 XX2X	0-50 PSIG	0-3.5 BAR
515 XX3X	0-100 PSIG	0-7 BAR
515 XX4X	0-250 PSIG	0-17 BAR
515 XX5X	0-400 PSIG	0-27.5 BAR
515 XX7X	0-150 PSIG	0-10 BAR

Models with the optional Altos 2 remote alarm provide an audible and visual warning that a switchover is about to occur. Pressing a button on the front of the remote alarm silences the audible alarm. The LEDs and the LCD display on the Altos 2 alarm indicate the status of the left and right banks.

Standard System Configuration (Line Regulator Not Included)

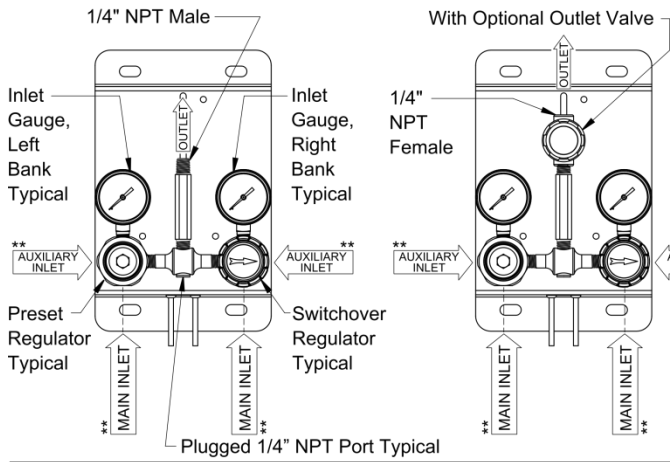

System Configuration with Integral Line Regulator

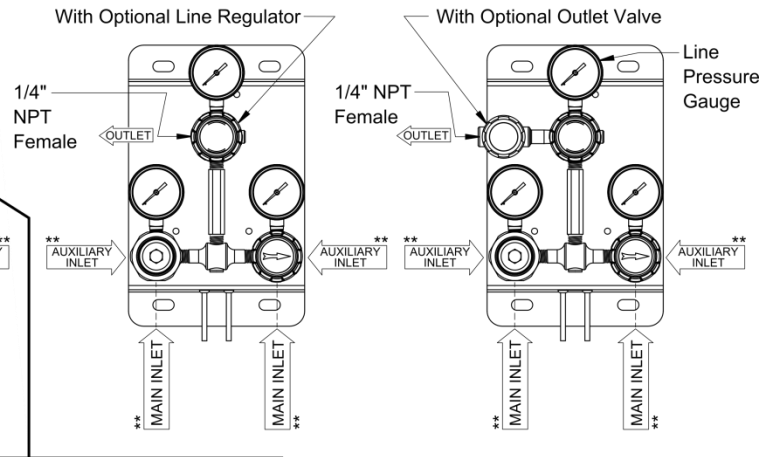

Models with Standard Transducers

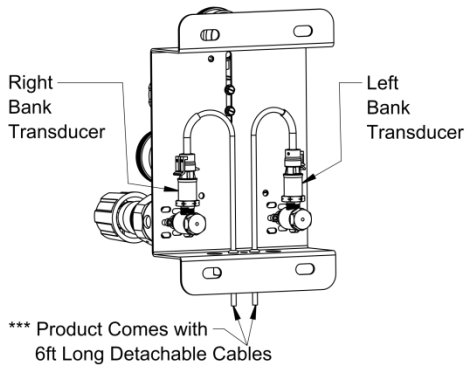

Models with Intrinsically Safe Transducers

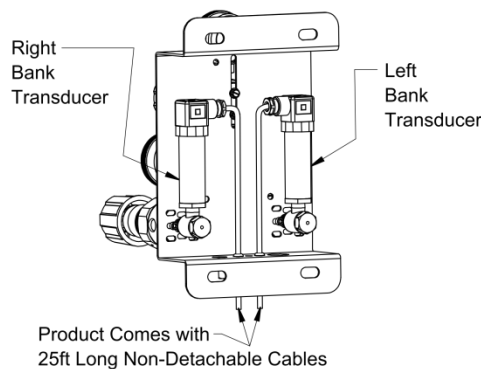

* The following replacement transducer cables are available:

- 5295360-006 = 6ft
- 5295360-025 = 25ft
- 5295360-100 = 100ft

** For the 515 Series, the bottom inlets are the main inlets. For models without purges, the auxiliary inlets may be used for supply gas input.

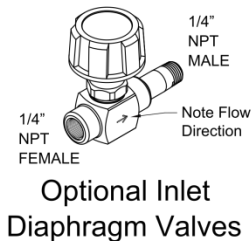

Optional Inlet Diaphragm Valves

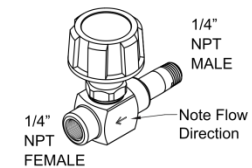

Optional Purge Valves (Installed in Aux. Inlets)

Optional Pigtails with Cylinder Connections

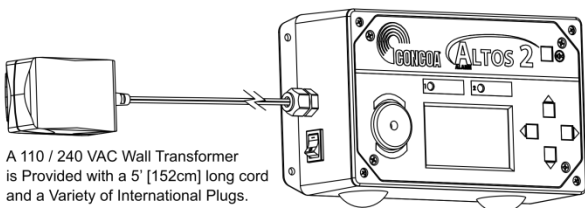
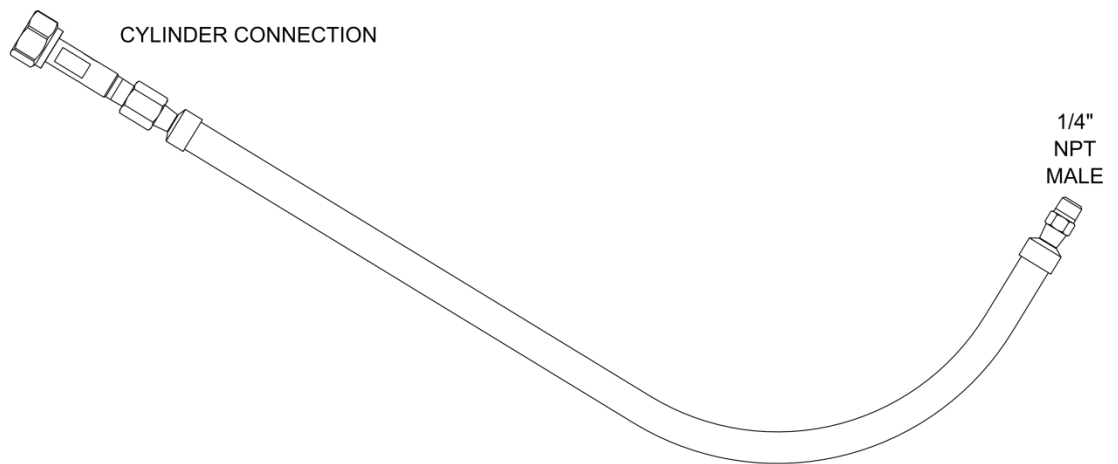

Optional Altos 2 Remote Alarm

Refer to CONCOA
Instruction Document
99060025-24V (ADI0025-24V)
For Alarm and Barriers
Wiring Instructions

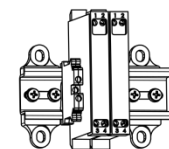

Optional Intrinsic Safety Barriers

Figure 1 – System Configurations and Parts

INTENDED USE OF PRODUCT

The SilcoNert[®] 2000 treated stainless steel switchover system (515 series) is for use in ultra high purity, corrosive, and toxic gas applications. Please note the safety information shown in the later sections.

USER RESPONSIBILITY

This equipment will perform in conformity with the description contained in this manual and accompanying labels and/or inserts when installed, operated, maintained, and repaired in accordance with the instructions provided. This equipment must be checked periodically. Improperly working equipment should not be used. Parts that are broken, missing, worn, distorted or contaminated, should be replaced immediately. CONCOA recommends that a telephone or written request for service advice be made to CONCOA Customer Service in Virginia Beach, Virginia.

PHONE: 1-800-225-0473, FAX: 1-757- 422-3125, or E-MAIL: e-mail@concoa.com.

This equipment or any of its parts should not be altered without prior written approval by CONCOA. The user of this equipment shall have the sole responsibility for any malfunction that results from improper use, faulty maintenance, damage, improper repair, or alteration by anyone other than CONCOA or a service facility designated by CONCOA.

CUSTOMER ASSISTANCE

In the event of equipment failure, call CONCOA Customer Assistance Line. Please be prepared to provide the model number and serial number of the equipment involved, in addition to some details regarding its application. This would include inlet and outlet pressures, flow rate, environmental conditions, and gas service.

Things to consider before removing the system from the box....

1. Know the properties and special handling requirements of the gas being used. Many specialty gases are quite dangerous (flammable, toxic, corrosive, asphyxiant, or oxidizers). Equipment failure or misuse may lead to problems such as a release of gas through the relief valve or regulator diaphragm. Proper safety measures, such as the use of gas cabinets or gas detectors, should be established to handle these and other component failures.
2. Be sure that the assembly purchased is suitable for the gas and type of service intended. The regulator label provides the following information:
 - a. Model number
 - b. Serial number
 - c. Maximum inlet pressure

Be sure that the equipment received conforms to the order specifications. The user is responsible for selecting equipment compatible with the gas in use, and conditions of pressure, temperature, flow, etc. Selection information can be found in CONCOA's *Pressure and Flow Control Specialty Gas Catalog*. In addition, CONCOA representatives are trained to aid in the selection process.

3. Inspect the assembly upon receipt to be sure that there is no damage or contamination. Pay particular attention to connecting threads. While CONCOA assembles system components to exacting leak-tight standards, the customer should also inspect for any loosening of parts that may occur in shipping or installation. Loose parts may be dangerously propelled from an assembly. If there are adverse signs (leakage or other malfunction), return the assembly to the supplier. While it is advised that soiled regulators be returned for cleaning, simple external dust or grease may be removed by a clean cloth and if required with aqueous detergent suitable for the application. If there are signs of internal contamination, return to the supplier.
4. Before system startup, it is recommended that all systems be pressure tested, leak tested, and purged with an inert gas such as nitrogen. To accomplish this with connections other than a CGA 580, it will be necessary to use an adapter. The recommended use of an adapter is for temporary use, for start-up and system checks only. Adapters should never be used on a permanent basis.



GENERAL SAFETY PRACTICES

- √ Comply with precautions listed in C.G.A. Pamphlet P-1, Safe Handling of Compressed Gases in Containers.
- √ Consult the cylinder distributor for the proper use of cylinders and for any restrictions on their use (such as flow rate and temperature requirements).
- √ Store cylinders with valve caps screwed on, and cylinders chained to a supporting wall or column.
- √ Handle cylinders carefully and only with valve caps screwed on. The cap will reduce the chance that the cylinder valve will break off if the cylinder is accidentally dropped or falls over. The cap also protects the cylinder valve from damage to screw threads, which could cause leaky connections.
- √ All manifolds used with flammable gases should be provided with approved flashback arrestors to stop any burning gas in the pipeline from getting back to the manifold or cylinders.
- √ No smoking should be permitted near oxygen, nitrous oxide, any other oxidizer, flammable gases, or flammable mixtures, or in areas where cylinders are stored.
- √ Where an oxidizer (such as NO₂ or O₂) is used, the manifold and cylinders must be kept clean. No oil, grease, or combustible substances should come in contact with oxygen or nitrous oxide storage or handling equipment. Such materials in contact with oxygen or nitrous oxide are readily ignitable and when ignited, will burn intensely.
- √ Never lift gas cylinders with a magnetic lifting device.
- √ Never use an open flame when leak testing.
- √ Always open valves slowly when high-pressure gases are being used.
- √ Always be sure that a cylinder contains the correct gas before connecting it to any manifold.
- √ Always leak-test any manifold or distribution pipeline before using.
- √ Always be sure that the gas in a pipeline is the correct gas for the intended use.
- √ Always close all cylinder valves before disconnecting cylinders from a manifold.
- √ Always remove all empty cylinders from a manifold before connecting full cylinders.
- √ Always test cylinders to be sure the cylinders are full before connecting to a manifold.

All gas distribution piping systems must meet the appropriate industrial standards for the intended service and must be thoroughly cleaned before using. For the United States, some applicable safety rules and precautions are listed below:

1. American National Standards Institute standard Z49.1, Safety in Welding and Cutting, American Welding Society, 2501 NW Seventh Street, Miami, Florida 33125
2. N.F.P.A. Standard 51, Oxygen-Fuel Gas systems for Welding and Cutting, N.F.P.A., 470 Atlantic Avenue, Boston, Massachusetts 02210
3. N.F.P.A. Standard 51B, Cutting and Welding Processes (same address as #2).
4. N.F.P.A. Standard 55, Compressed Gases and Cryogenic Fluids Code
5. CONCOA publication ADE 872, Safety Precautions in Welding and Cutting.
6. Local Ordinances
7. O.S.H.A. Standard 29 CFR
8. C.G.A. Pamphlet C-4, American National Standard Method of Marking Portable Compressed Gas Containers to Identify the Material Contained.
9. C.G.A. Pamphlet G-4, Oxygen – Information on the properties, manufacture, transportation, storage, handling, and use of oxygen.
10. C.G.A. Pamphlet G-4.1, Equipment Cleaned for oxygen service.
11. C.G.A. Pamphlet G-4.4, Industrial Practices for Gaseous Oxygen Transmission and Distribution Piping Systems.
12. C.G.A. Pamphlet G-5, Hydrogen – Information on the properties, manufacture, transportation, storage, handling, and use of hydrogen.
13. C.G.A. Pamphlet G-6, Carbon Dioxide – Information on the properties, manufacture, transportation, storage, handling, and use of carbon dioxide.
14. C.G.A. Pamphlet G-6.1, Standard for Low Pressure Carbon Dioxide Systems at Consumer Sites.
15. C.G.A. Pamphlet P-1, Safe Handling of Compressed Gases in Containers.
16. C.G.A. Safety Bulletin SB-2, Oxygen Deficient Atmospheres.

*C.G.A. pamphlets can be obtained from the Compressed Gas Association, 1235 Jefferson Davis Highway, Arlington, VA 22202- 3239, (703) 979-0900. Publications: (703) 979-4341. Fax: (703) 979-0134.

CAUTION

INSTALLATION

Keep all cylinders and switchovers away from any source of high temperature over 120°F (50°C) or possible fire hazards. High-pressure gas contained in a closed cylinder becomes increasingly dangerous when exposed to high temperature because pressure increases and the strength of the cylinder decreases. Switchovers installed in open locations should be protected from weather conditions. During winter, protect the system from ice and snow. In summer, shade the system and cylinders from continuous exposure to direct sunlight. Always leave access to the system for cylinder replacement.

The site chosen for the system installation shall be level, well ventilated, and at a safe distance from sources of flames, sparks, and excessive heat. The system should not be placed in an area that may subject the system to damage from passing forklifts, trucks, or other heavy machines. Oxygen systems must not be installed under shafting, belting, or other places where oil can drip on them. For other location guidelines, see NFPA standard 51.

Consider the following when installing the system.

1. Be sure to consider all factors when selecting materials.
2. Do not use oil or grease on fittings.
3. Be sure that all fittings are secure and leak tight. Teflon tape should be used on pipe threads.
4. If constant pressure is required, a line regulator will need to be installed. If the line regulator is not integral with the switchover system (see part number key at end of this document), then a decision will need to be made regarding where downstream from the switchover outlet a line regulator will be installed.
5. Captured Vents for the Regulator Bonnets: Captured vent kits #550 0001 can be added to the 515 series as an accessory. These vent kits are added to each of the regulator bonnets (preset regulator, switchover regulator, and line regulator if present) on the switchover to redirect gas in the event of a diaphragm failure. When installing the vent kits, be sure to connect suitable tubing from the vent kit fitting to the safe discharge area.
6. Purge devices: These devices are optional. Purge devices are used to remove toxic, corrosive, or flammable gases from the customer's system to a safe discharge area. This is particularly helpful when an internal problem occurs (such as regulator malfunction).

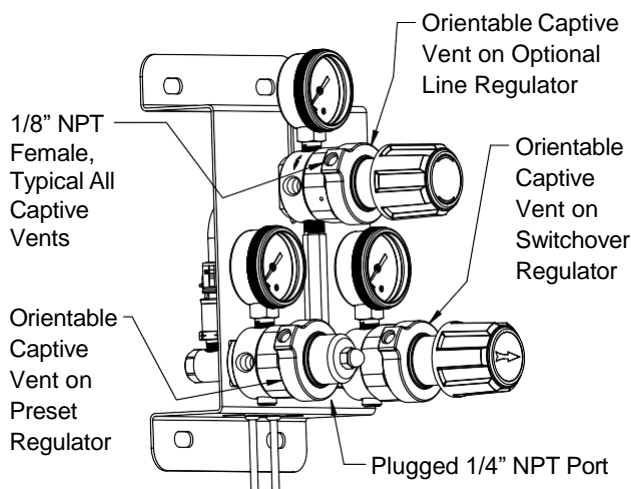

Figure 2 - Location of Inter-Stage Port

Mount the switchover system to a flat surface using the appropriate hardware at hole locations provided in the bracket. Dimensions for these holes are shown Figure 3. Provide enough clearance between the top of the cylinder and the switchover system. The typical installation for high-pressure cylinders needs 66 inches between the floor and the "MAIN INLET" port.

Install inlet and outlet connections to the regulator. Use an open-end wrench, not a pipe wrench, to install accessories to the switchover system. 1/4" NPT connections require the use of PTFE tape on the threads to make a gas tight seal. On SilcoNert[®] 2000 treated stainless steel connections, the PTFE tape helps prevent the connections from galling together when tightening or loosening. CONCOA uses PTFE tape on all of its regulator NPT connections.

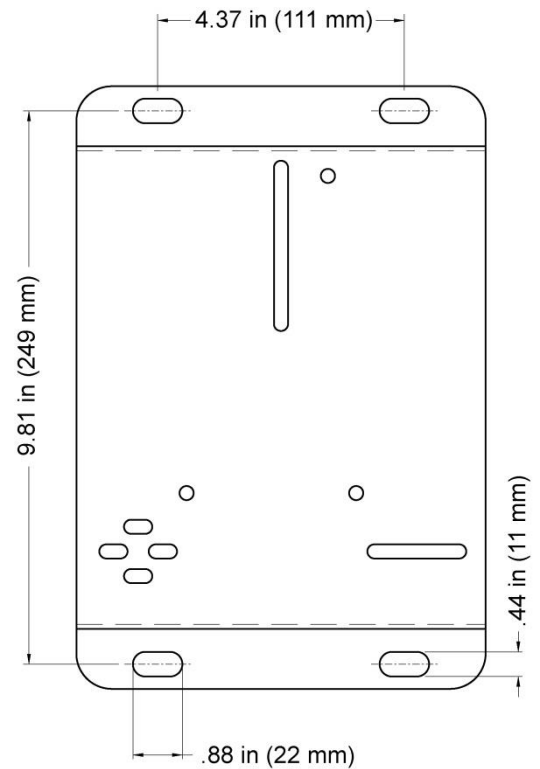

Figure 3 – Installation Bracket

Follow these rules when using PTFE tape:

- Do not use oil or grease on fittings. This is especially important for oxidizing gas service.
- PTFE tape must be used on NPT threads to ensure a gas-tight seal. Avoid impinging on the gas stream. PTFE tape also helps to prevent the connections from galling together when tightening or loosening.
- Before applying PTFE tape, inspect the NPT threads, and, if necessary, clean the fitting to remove any dirt or thread sealant that remains on the threads.
- Start the PTFE tape on the first thread, leaving a slight section of the chamfer exposed as shown in Figure 4. Make sure the tape does not overlap the end of the fitting.
- As tape is wound in the direction of the thread spiral, pull tightly on the end of the tape so that the tape conforms to the thread.
- Apply at least 2 but no more than 3 layers of tape to the threads. Press the end firmly into the threads.

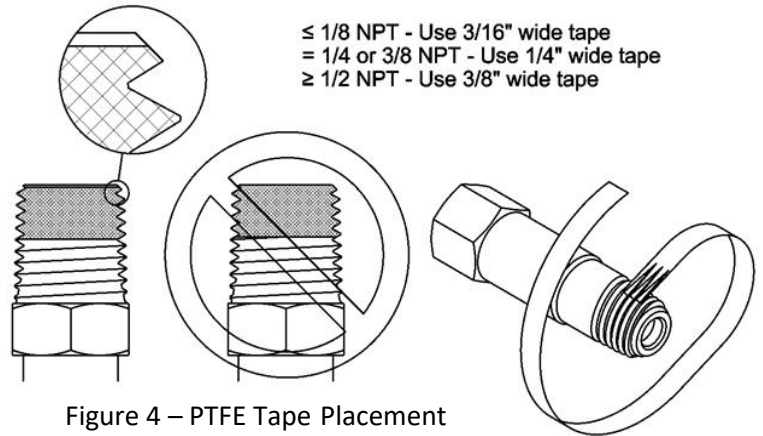

Figure 4 – PTFE Tape Placement

Installing the inlet connection:

If purchased with pigtailed, the 1/4" NPT male end of each pigtail will need to be installed into the "MAIN INLET" ports on the preset and the switchover regulators or into the open female ports of each optional diaphragm valve installed in the "MAIN INLET" ports.

The connection available at the other end of the pigtail will depend on how the system was purchased. If the pigtail does not have a cylinder connection installed, there will be a 1/4" NPT female fitting on the end of the pigtail. The 1/4" NPT female pigtail end will connect to the user's system. If configured with a CGA connection or international inlet connection, the connection will be specific to the particular cylinder of gas to be used. Some connections do require the use of a gasket. Please note that the material of the gasket must also be compatible with the type of gas being used. Be familiar with the type of connection being used, and its proper procedures for installation.

Connecting to a cylinder:

1. Before removing the cylinder cap, move the cylinder of gas to the work site:
 - a. Secure cylinder to the floor, wall, or bench with appropriate chain, strap, or stand to prevent toppling.
 - b. Remove the cylinder cap.
 - c. Be sure the cylinder valve is tightly closed (clockwise)
 - d. Remove the cylinder valve plug, if any.
 - e. Inspect the cylinder valve and threads for damage or contamination.
2. Secure the cylinder connection to the cylinder in the following manner:
 - a. Do not force. Tightening the nut onto the cylinder connection should be easy. If it is not, the connection may be wrong for the type of gas being used.
 - b. Left-hand threads are used on some cylinder connections. A notch in the middle of the hex nut typically indicates a left-hand thread.
 - c. Gaskets are used on some inlet connections. Be sure the gasket is in good shape. Do not over-tighten to avoid squashing the gasket into the gas line. Keep extra gaskets on hand.
 - d. Never use oil or grease on regulator or cylinder fittings, as it may contaminate pure gases, or create a fire hazard.

Installing the outlet connection:

The standard system configuration (line regulator not included) has the outlet connection at the top of the switchover system. The connection is a ¼" NPT male fitting for models without the optional diaphragm valve; ¼" NPT female port for models with the optional diaphragm valve

For models with an integral line regulator, connections will be made at the ¼" NPT female port on the line regulator or to the ¼" NPT female port on the optional outlet valve.



Pressurizing the system for the first time:

Before system startup, it is recommended that all systems be pressure tested, leak tested, and purged with an inert gas such as nitrogen. To accomplish this with connections other than a CGA 580, it will be necessary to use an adapter. The recommended use of an adapter is for temporary use only, for system start up and checks. Adapters should never be used on a permanent basis.

1. Wear safety glasses and gloves.
2. Be sure that both ends of all hoses or pigtails are secured before pressurizing. On the system with the line regulator, turn the line regulator knob counterclockwise until the knob stops turning.
3. When first pressurizing, do not stand in front of or contact the switchover system. Slowly open the cylinder valve. Observe the high pressure gauge for a rise in pressure up to full cylinder pressure. Warning - if this system is equipped without the line regulator, the outlet will pressurize when the cylinder valve is opened.
4. Keep the hand wheel or wrench on the open cylinder valve at all times, to allow prompt emergency shut-off.
5. Inspect all connections for leaks and fix any leaks. A leak detection solution may be applied to the connections (if compatible with the application) which indicates leaks by bubbling. To further check for leaks, or if the leak detection solution can not be used, close the cylinder valve for a period of time (recommended 24 hours), and observe the high pressure gauge for a drop in pressure. If so indicated, recheck the CGA connection and all other high-pressure port connections. If equipped without the line regulator, the outlet connections will also need to be rechecked.
6. Never attempt to fix a leak under pressure. If leaks are detected, depressurize the system and retighten the connection. Begin again at step 3.
7. If equipped with the optional line regulator, slowly turn the line regulator knob clockwise. This will increase the pressure of the line. Adjust to the desired working pressure and again check for leaks using the methods described above.

OPERATION

The arrow on the priority valve always points to the primary side; the bank opposite the primary side is considered the reserve side. Starting with the arrow pointing to the right side, gas will flow from the right side cylinder. As the gas in the primary side is depleted, the gas pressure will drop on the gauge of the primary regulator. When the pressure drops to the pressure setting of the reserve side regulator, flow will begin from the reserve cylinder; the inlet pressure on the primary side will stabilize. This is called a changeover. At this point, the gas pressure on the reserve side (preset regulator) will drop. This indicates that its time to change the cylinders on the primary side. Before removing the nearly depleted primary cylinder, the priority valve should be rotated 180°. This makes the reserve cylinder the primary source. Remove the depleted cylinder and replace with a full cylinder. Before removing the cylinder be sure to close the cylinder valve and any other valves that connect the cylinder to the system. The full, replacement cylinder is now the reserve cylinder. Note: while changing cylinders on one side, there will be no interruption in flow. A depleted cylinder will have the following gas pressure remaining:

MODEL NUMBER	Depleted Gas Supply Pressure at the Changeover Point (Maximum Line Pressure for Models Without the Integral Line Regulator)	
	Left Side	Right Side
515 4xxx	165-175 PSIG (11.4-12.1 BAR)	165-245 PSIG (11.4-16.9 BAR)
515 5xxx	455-475 PSIG (31.4-32.8 BAR)	455-545 PSIG (31.4-37.6 BAR)
515 8xxx	255-275 PSIG (17.6-19.0 BAR)	255-345 PSIG (17.6-23.8 BAR)

Gas will continue to flow from the primary side until the outlet pressure of the preset regulator matches the pressure of the priority valve regulator. (The pressure setting of the priority valve regulator changes when the knob is turned 180°). When the gas pressure stops dropping on the preset regulator and starts to drop on the priority valve regulator, it is time to change the left cylinder. The knob is rotated 180° to the right before the left cylinder is changed. It is helpful to maintain a log of cylinder pressure, noting which direction the arrow is pointing on the priority valve. When the pressure gauge is very low and the reserve side indicates that gas has begun to flow from the reserve cylinder, it is time to rotate the knob and attach a full cylinder in reserve.

If the knob is not rotated before the empty cylinder is changed, two things can happen. First, gas may flow from the changed cylinder to the existing cylinder. This is because the pressure setting of the regulator on the primary side allows the regulator main valve to remain open. Second, when the cylinder is changed, gas will begin to flow from the new cylinder, stopping flow from the existing cylinder. This means the existing cylinder may be partially empty. After several cycles, it is possible that the reserve cylinder may empty shortly after a switchover occurs. Always remember to rotate the knob on the priority valve regulator before changing a depleted cylinder.

MAINTENANCE

On regular intervals, the system should be checked for leaks and proper function (see trouble shooting). Any leaks in the system should be corrected immediately. The pigtail checkvalve should also be checked for leaks when a depleted cylinder is removed. NOTE: the system inlet and pigtail should be pressurized when checking for leaks. At no time should the preset regulator's or priority valve regulator's pressure settings be changed.

TROUBLE SHOOTING

Typical symptoms listed below indicate regulator malfunctions needing repair. Replace immediately with a clean, repaired and tested, or new system.

1. Gas leakage at the line regulator outlet when the adjusting screw of the line regulator is completely backed out.
2. With no flow through the system (downstream valves closed and adjusting screw in) line pressure steadily increases above set pressure.
3. Gas leakage from spring case (adjusting screw/knob end off regulator).
4. Gas leakage from any joint.
5. Excessive drop in working pressure with regulator flowing gas.
6. Gas leakage from relief valve.
7. Gas leakage from gauge
8. Gauge does not return to zero when not under gas pressure
9. Gauge does not consistently repeat the same reading.
10. The system makes a noise or hums.

If the switchover system seems to be using gas from the primary and reserve cylinders (pressure is decreasing on both inlet gauges at the same time), do the following:

1. Make sure the priority valve knob is turned fully to the right or left.
2. Observe the inlet pressure. It may be necessary to do this during the heaviest use of the system. If the inlet pressure is below the values listed below, replace the high-pressure cylinders. If liquid cylinders are used and the inlet pressure increases significantly when the system is not in use, then the system is over-withdrawing the liquid cylinders. Additional capacity may be added to the system to prevent this.

515 4XXX	205 PSIG
515 5XXX	500 PSIG
515 8XXX	300 PSIG

3. If the above does not fix the problem, please contact a CONCOA customer service personnel. Please be prepared to give the following:
 - Model number
 - Gas service
 - Inlet pressure and type of gas supply
 - Outlet pressure
 - Approximate gas usage

SERVICE

A unit that is not functioning properly should not be used. It is recommended that all servicing be done by a service facility authorized by CONCOA. Contact CONCOA Customer Service in Virginia Beach, Virginia for systems still covered by the warranty. For items not covered by the warranty, contact the nearest CONCOA District Sales Office for assistance.

If so advised, the unit should be sent to a service facility authorized by CONCOA. Do the following before shipping:

1. Adequately package the system. If possible package in the original shipping container.
2. Ship prepaid.
3. Include a statement of the observed deficiency.
4. Indicate the gas service that the equipment was used on.
5. Purge all equipment before shipment to protect the transporter and service personnel. The purging is especially important if the equipment has been in hazardous or corrosive gas service.

Return trip transportation charges are to be paid by the Buyer. In all cases where the warranty has expired, repairs will be made at current list price for the replacement part(s), plus a reasonable labor charge.

515 Series Switchover Part No.:

3000 PSI Max. Inlet Models

4th digit 5th digit 6th digit 7th digit Inlet Connection Code last digit
515 [] [] [] [] -01- [_ _ _] []

Outlet Styles

__ (blank) = Open 1/4" NPT Port
A = Add Outlet Diaphragm Valve
B = Add Outlet Diaphragm Valve
+ Inlet Purge Valves
V = Add Inlet Purge Valves

Inlet Connection Type

-001 = Without Pigtails
-000 = Pigtails with 1/4" NPT Female Port
-### = Pigtails with Cylinder Connections

Transducer Style / Alarm / Inlet Gauges

G = Standard Transducers / With Alarm /
4000 PSI Gauges
H = Standard Transducers / With Alarm /
600 PSI Gauges
J = Standard Transducers / Without Alarm /
4000 PSI Gauges
K = Standard Transducers / Without Alarm /
600 PSI Gauges
L = Intrinsically Safe Transducers & Safety Barriers /
With Alarm / 4000 PSI Gauges
M = Intrinsically Safe Transducers & Safety Barriers /
With Alarm / 600 PSI Gauges
N = Intrinsically Safe Transducers & Safety Barriers /
Without Alarm / 4000 PSI Gauges
P = Intrinsically Safe Transducers & Safety Barriers /
Without Alarm / 600 PSI Gauges

Outlet Styles

0 = Without Integral Line Regulator
1 = 0- 15 PSI Integral Line Regulator
2 = 0 -50 PSI Integral Line Regulator
3 = 0-100 PSI Integral Line Regulator
4 = 0-250 PSI Integral Line Regulator
5 = 0-400 PSI Integral Line Regulator
7 = 0-150 PSI Integral Line Regulator
A = 0- 15 PSI Integral Line Regulator for Acetylene

Inlet Styles

0 = Open 1/4" NPT Ports
1 = 36" Pigtails
3 = 24" Pigtails
4 = Diaphragm Valves
5 = Diaphragm Valves + 36" Pigtails
7 = Diaphragm Valves + 24" Pigtails
A = 72" Pigtails
B = Diaphragm Valves + 72" Pigtails

Switchover Pressure

4 = Left: 160-180 psig / Right: 193-218 psig
5 = Left: 445-485 psig / Right: 480-520 psig
8 = Left: 245-285 psig / Right: 280-320 psig

THIS PAGE INTENTIONALLY LEFT BLANK

THIS PAGE INTENTIONALLY LEFT BLANK

Warranty Information

This equipment is sold by CONTROLS CORPORATION OF AMERICA under the warranties set forth in the following paragraphs. Such warranties are extended only with respect to the purchase of this equipment directly from CONTROLS CORPORATION OF AMERICA or its Authorized Distributors as new merchandise and are extended to the first Buyer thereof other than for the purpose of resale.

For a period of one (1) year from the date of original delivery (90 days in corrosive service) to Buyer or to Buyer's order, this equipment is warranted to be free from functional defects in materials and workmanship and to conform to the description of this equipment contained in this manual and any accompanying labels and/or inserts, provided that the same is properly operated under conditions of normal use and that regular periodic maintenance and service is performed or replacements made in accordance with the instructions provided. The foregoing warranties shall not apply if the equipment has been repaired: other than by CONTROLS CORPORATION OF AMERICA or a designated service facility or in accordance with written instructions provided by CONTROLS CORPORATION OF AMERICA, or altered by anyone other than CONTROLS CORPORATION OF AMERICA, or if the equipment has been subject to abuse, misuse, negligence or accident.

CONTROLS CORPORATION OF AMERICA's sole and exclusive obligation and Buyer's sole and exclusive remedy under the above warranties is limited to repairing or replacing, free of charge, at CONTROLS CORPORATION OF AMERICA's option, the equipment or part, which is reported to its Authorized Distributor from whom purchased, and which if so advised, is returned with a statement of the observed deficiency, and proof of purchase of equipment or part not later than seven (7) days after the expiration date of the applicable warranty, to the nearest designated service facility during normal business hours, transportation charges prepaid, and which upon examination, is found not to comply with the above warranties. Return trip transportation charges for the equipment or part shall be paid by Buyer.

CONTROLS CORPORATION OF AMERICA SHALL NOT BE OTHERWISE LIABLE FOR ANY DAMAGES INCLUDING BUT NOT LIMITED TO: INCIDENTAL DAMAGES, CONSEQUENTIAL DAMAGES, OR SPECIAL DAMAGES, WHETHER SUCH DAMAGES RESULT FROM NEGLIGENCE, BREACH OF WARRANTY OR OTHERWISE.

THERE ARE NO EXPRESS OR IMPLIED WARRANTIES WHICH EXTEND BEYOND THE WARRANTIES HEREINABOVE SET FORTH. CONTROLS CORPORATION OF AMERICA MAKES NO WARRANTY OF MERCHANTABILITY OR FITNESS FOR A PARTICULAR PURPOSE WITH RESPECT TO THE EQUIPMENT OR PARTS THEREOF.



Controls Corporation of America
1501 Harpers Road Virginia Beach, VA 23454
To Order Call 1-800-225-0473 or 757-422-8330 • Fax 757-422-3125
www.concoa.com